



Range of centrifugal roof mounted fans in horizontal discharge format, designed for smoke extraction in fire conditions and certified F400-120 (1).

Suitable for air stream temperature up to 120°C.

- Base manufactured from galvanised sheet steel.
- High efficiency centrifugal backward curved impeller manufactured from galvanized sheet steel.
- Cowl manufactured from spun aluminium.
- All models incorporate bird-proof guard.
- Available, depending on the model, in 4, 6 or 4/8 poles.

(1) Except 180 and 200 models

Motors

- Single-phase, single-speed motor 220-240V50Hz (CTHB), IP55, class F, with safety thermal overload protection*. Speed controllable by voltage**.
- Three-phase single-speed motor 220-240/400-415V-50Hz (CTHT), IP55, class F, with safety thermal overload protection*. Speed controllable by frequency inverter and by voltage**.
- Three-phase 2-speed motor 380-415V50Hz, 4/8 poles, IP55, class F, with safety thermal overload protection*.

* When thermal protection are connected, the electrical installation must be equipped with a security system that, in case of fire, allows the maximum speed of the fans whatever the current state of the thermal protection.

** When using a speed controller, the electrical installation must be equipped with a security system that allows, in case of fire, the maximum speed of the fans.

Only F400-120 at maximum fan speed.

Additional information

180N, 200N and 225N models are specially designed for extracting smokes from fireplaces.

HORIZONTAL DISCHARGE MODELS



Easy to install
 Eyebolt to ease the installation on the roof.

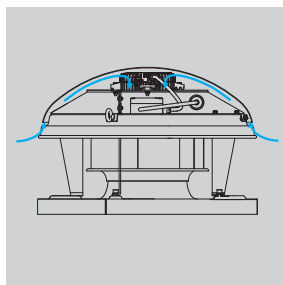

Self cooling system
 Special design in order to cool the motor and to extend the life of the assembly.

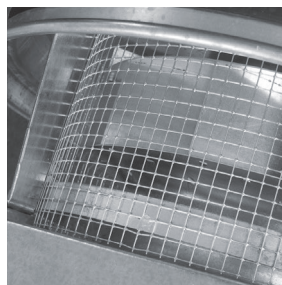

Bird-proof guard.

Specific applications



Approved to EN12101-3 standard
 Certificate n° 0370-CPD-0347



Continuous operation



Car parks



Industrial and commercial kitchens

Additional applications for 180N, 200N and 225N models



Continuous



Smoke extract



Range of centrifugal roof mounted fans in vertical discharge format, designed for smoke extraction in fire conditions and certified F400-120(1).

Suitable for air stream temperature up to 120°C.

- Base manufactured from galvanised sheet steel.
- High efficiency centrifugal backward curved impeller manufactured from galvanized sheet steel.
- Cowl manufactured from spun aluminium.
- All models incorporate bird-proof guard.
- Available, depending on the model, in 4, 6 or 4/8 poles.

(1) Except 180 and 200 models

Motors

- Single-phase, single-speed motor 220-240V50Hz (CTVB), IP55, class F, with safety thermal overload protection*. Speed controllable by voltage**.
- Three-phase, single-speed motor 220- 240/400-415V-50Hz (CTVT), IP55, class F, with safety thermal overload protection*. Speed controllable by frequency inverter and by voltage**.
- Three-phase, 2-speed motor 380-415V50Hz, 4/8 poles, IP55, class F, with safety thermal overload protection*.

* When thermal protection are connected, the electrical installation must be equipped with a security system that allows the maximum speed of the fans in case of fire, whatever the current state of the thermal protection.

** When using a speed controller, the electrical installation must be equipped with a security system that allows the maximum speed of the fans in case of fire.

Only F400-120 at maximum fan speed.

Additional information

180N, 200N and 225N models are specially designed for extracting smokes from fireplaces.

VERTICAL DISCHARGE MODELS

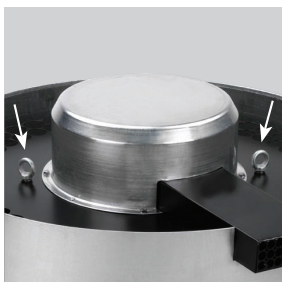

Easy to install
 Eyebolt to ease the installation on the roof.

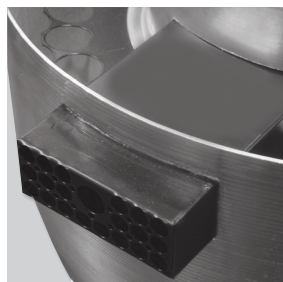

Cooling duct
 Enables the motor cooling when the fan is extracting air at an extremely high temperature.



Bird-proof guard.

Specific applications



Approved to EN12101-3 standard
 Certificate n° 0370-CPD-0347



Continuous operation



Car parks



Industrial and commercial kitchens

Additional applications for 180N, 200N and 225N models



Continuous



Smoke extract

CENTRIFUGAL ROOF MOUNTED FANS MAX-TEMP CTHB-N/CTHT-N Series - HORIZONTAL DISCHARGE



TECHNICAL CHARACTERISTICS

Before making any electrical connection ensure that the voltage and frequency of the mains electrical supply matches that of the fan data plate label.

Model type	Speed (rpm)	Maximum absorbed power (W)	Maximum absorbed current (A-230V)**	Maximum air volume (m³/h)	Sound pressure level* (dB(A))		Weight (kg)	Speed controller REB
					Inlet	Outlet		

SINGLE-PHASE 4 POLE MOTORS

CTHB/4-180N	1290	65	0,3 [0,3]	900	44	48	10,8	REB-1N
CTHB/4-200N	1410	87	0,4 [0,5]	1.260	48	53	18	REB-1N
CTHB/4-225N	1410	163	0,7 [1]	2.000	51	56	20	REB-2,5N
CTHB/4-250N	1400	295	1,3 [1,6]	2.750	52	58	32	REB-2,5N
CTHB/4-315N	1410	583	2,6 [3,2]	4.440	60	65	35	REB-5
CTHB/4-400N	1410	1168	5,1 [6,5]	7.120	66	73	51,5	REB-10

SINGLE-PHASE 6 POLE MOTORS

CTHB/6-200N	920	34	0,1 [0,2]	820	38	42	17,5	REB-1N
CTHB/6-225N	900	61	0,3 [0,3]	1.330	40	43	22,5	REB-1N
CTHB/6-250N	900	91	0,4 [0,4]	1.770	42	47	30,5	REB-1N
CTHB/6-315N	900	179	0,8 [0,8]	2.900	49	53	33	REB-1N
CTHB/6-400N	920	353	1,6 [1,8]	4.640	55	61	46	REB-2,5N

* Sound pressure level measured at 3 m in hemi-spherical propagation, at the duty point 2 of the performance curve.

** (in brackets): maximum current when speed controlled by tension.

Model type	Speed (rpm)	Maximum absorbed power** (W)	Maximum absorbed current**		Maximum air volume (m³/h)	Sound pressure level* (dB(A))		Weight (kg)	Frequency inverter			
			230V	400V		Inlet	Outlet		VFKB		VFTM	
									1-230V	3-400V	1-230V	3-400V

THREE-PHASE 4 POLE MOTORS

CTHT/4-180N	1280	60	0,2	0,1	890	44	48	10,8	VFKB 24	VFKB 45	MONO 0,18	TRI 0,37
CTHT/4-200N	1400	84	0,3	0,2	1.250	48	52	17,5	VFKB 24	VFKB 45	MONO 0,18	TRI 0,37
CTHT/4-225N	1400	163	0,5	0,3	2.010	51	55	18,5	VFKB 24	VFKB 45	MONO 0,18	TRI 0,37
CTHT/4-250N	1370	279	1,0	0,6	2.710	52	58	31,5	VFKB 24	VFKB 45	MONO 0,18	TRI 0,37
CTHT/4-315N	1400	548	1,9	1,1	4.490	60	65	33	VFKB 24	VFKB 45	MONO 0,37	TRI 0,37
CTHT/4-400N	1430	1126	4,2	2,4	7.120	65	73	49,5	VFKB 27	VFKB 45	MONO 0,75	TRI 1,1

THREE-PHASE 6 POLE MOTORS

CTHT/6-200N	880	32	0,1	0,3	800	37	41	17,5	VFKB 24	VFKB 45	MONO 0,18	TRI 0,37
CTHT/6-225N	910	62	0,2	0,1	1.310	40	43	19,5	VFKB 24	VFKB 45	MONO 0,18	TRI 0,37
CTHT/6-250N	880	89	0,3	0,2	1.760	41	46	30,5	VFKB 24	VFKB 45	MONO 0,18	TRI 0,37
CTHT/6-315N	910	180	0,7	0,4	2.890	49	53	35	VFKB 24	VFKB 45	MONO 0,18	TRI 0,37
CTHT/6-400N	930	344	1,4	0,8	4.770	55	61	44	VFKB 24	VFKB 45	MONO 0,18	TRI 0,37

* Sound pressure level measured at 3 m in hemi-spherical propagation, at the duty point 2 of the performance curve.

** At 50Hz without VSD.

Model type	Speed (RPM)		Maximum absorbed power (W)		Maximum absorbed current (400V)		Maximum air volume (m³/h)		Sound pressure level* (dB(A) HS/LS)		Weight (kg)	Speed controller DEMZ
	HS	LS	HS	LS	HS	LS	HS	LS	Inlet	Outlet		

THREE-PHASE 4/8 POLE MOTORS

CTHT/4/8-225N	1380	710	163	79	0,3	0,2	1950	1000	51/36	55/40	18,5	-
CTHT/4/8-250N	1370	720	280	145	0,6	0,4	2750	1390	52/38	58/44	31,5	-
CTHT/4/8-315N	1400	700	548	260	1,1	0,9	4490	2240	60/45	65/50	33	DEMZ 1/1,3 DA
CTHT/4/8-400N	1350	710	497	181	0,9	0,6	4330	2160	59/46	64/51	49,5	DEMZ 1,3/3,1 DA

* Sound pressure level measured at 3 m in hemi-spherical propagation, at the duty point 2 of the performance curve.

DIMENSIONS (mm)

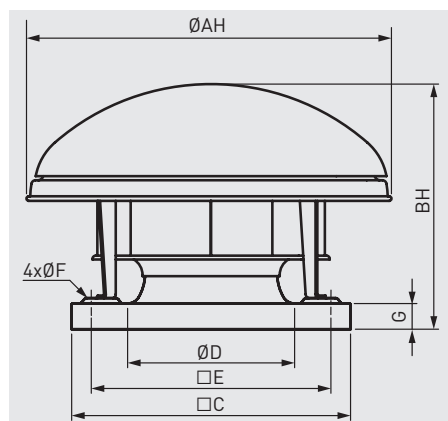

Fan model	AH	BH	□C	Ø D	□E	Ø F	G
180N	415	296	300	212	245	10	35
200N	570	345	435	234	330	12	40
225N	570	382	435	261	330	12	40
250N	778	432	560	289	450	12	40
315N	778	472	560	326	450	12	40
400N	850	540	630	420	535	12	40

CENTRIFUGAL ROOF MOUNTED FANS MAX-TEMP CTVB-N/CTVT-N Series - VERTICAL DISCHARGE



TECHNICAL CHARACTERISTICS

Before making any electrical connection ensure that the voltage and frequency of the mains electrical supply matches that of the fan data plate label.

Model type	Speed (rpm)	Maximum absorbed power (W)	Maximum absorbed current (A-230V)**	Maximum air volume (m³/h)	Sound pressure level* (dB(A))		Weight (kg)	Speed controller REB
					Inlet	Outlet		
SINGLE-PHASE 4 POLE MOTORS								
CTVB/4-180N	1310	73	0,3 [0,3]	870	45	49	11,7	REB-1N
CTVB/4-200N	1410	89	0,4 [0,5]	1.260	48	51	19,5	REB-1N
CTVB/4-225N	1400	166	0,7 [0,9]	1.910	53	57	19	REB-2,5N
CTVB/4-250N	1390	299	1,3 [1,6]	2.690	55	58	35,5	REB-2,5N
CTVB/4-315N	1410	587	2,7 [3,4]	4.340	59	62	35,5	REB-5
CTVB/4-400N	1420	1170	5,1 [6]	6.700	65	69	53	REB-10
SINGLE-PHASE 6 POLE MOTORS								
CTVB/6-200N	910	34	0,2 [0,2]	810	40	44	19,5	REB-1N
CTVB/6-225N	900	61	0,3 [0,3]	1.220	39	42	20	REB-1N
CTVB/6-250N	900	90	0,4 [0,4]	1.770	43	46	34	REB-1N
CTVB/6-315N	900	180	0,8 [0,9]	2.810	48	51	38	REB-1N
CTVB/6-400N	920	345	1,6 [1,8]	4.400	55	58	47,5	REB-2,5N

* Sound pressure level measured at 3 m in hemi-spherical propagation, at the duty point 2 of the performance curve.

** [in brackets]: maximum current when speed controlled by tension.

Model type	Speed (rpm)	Maximum absorbed power** (W)	Maximum absorbed current**		Maximum air volume (m³/h)	Sound pressure level* (dB(A))		Weight (kg)	Frequency inverter			
			230V	400V		Inlet	Outlet		VFKB		VFTM	
									1-230V	3-400V	1-230V	3-400V
THREE-PHASE 4 POLE MOTORS												
CTVT/4-180N	1260	62	0,2	0,1	840	45	48	11,7	VFKB 24	VFKB 45	MONO 0,18	TRI 0,37
CTVT/4-200N	1390	86	0,3	0,2	1230	48	50	19,5	VFKB 24	VFKB 45	MONO 0,18	TRI 0,37
CTVT/4-225N	1390	164	0,5	0,3	1830	53	57	22,5	VFKB 24	VFKB 45	MONO 0,18	TRI 0,37
CTVT/4-250N	1370	277	1,0	0,6	2660	54	57	35,5	VFKB 24	VFKB 45	MONO 0,18	TRI 0,37
CTVT/4-315N	1400	538	2,1	1,2	4320	58	62	35,5	VFKB 24	VFKB 45	MONO 0,37	TRI 0,37
CTVT/4-400N	1430	1139	4,0	2,3	6760	64	69	51	VFKB 27	VFKB 45	MONO 0,75	TRI 1,1

THREE-PHASE 6 POLE MOTORS

CTVT/6-200N	890	31	0,2	0,1	780	39	43	19	VFKB 24	VFKB 45	MONO 0,18	TRI 0,37
CTVT/6-225N	900	61	0,2	0,1	1210	40	43	22	VFKB 24	VFKB 45	MONO 0,18	TRI 0,37
CTVT/6-250N	880	86	0,3	0,2	1710	43	46	34	VFKB 24	VFKB 45	MONO 0,18	TRI 0,37
CTVT/6-315N	900	180	0,7	0,4	2800	48	51	39	VFKB 24	VFKB 45	MONO 0,18	TRI 0,37
CTVT/6-400N	930	345	1,4	0,8	4400	56	58	45,5	VFKB 24	VFKB 45	MONO 0,18	TRI 0,37

* Sound pressure level measured at 3 m in hemi-spherical propagation, at the duty point 2 of the performance curve.

** At 50Hz without VSD.

Model type	Speed (RPM)		Maximum absorbed power (W)		Maximum absorbed current (400V)		Maximum air volume (m³/h)		Sound pressure level* (dB(A) HS/LS)		Weight (kg)	Speed controller DEMZ
	HS	LS	HS	LS	HS	LS	HS	LS	Inlet	Outlet		
THREE-PHASE 4/8 POLE MOTORS												
CTVT/4/8-225N	1380	710	163	79	0,3	0,2	1770	900	53/38	56/42	18,5	-
CTVT/4/8-250N	1370	720	280	145	0,6	0,4	2670	1360	54/40	57/43	31,5	-
CTVT/4/8-315N	1400	700	548	260	1,1	0,9	4490	2240	60/45	65/50	33	DEMZ 1/1,3 DA
CTVT/4/8-400N	1350	710	497	181	0,9	0,6	4200	2160	58/44	61/48	49,5	DEMZ 1,3/3,1 DA

* Sound pressure level measured at 3 m in hemi-spherical propagation, at the duty point 2 of the performance curve.

DIMENSIONS (mm)

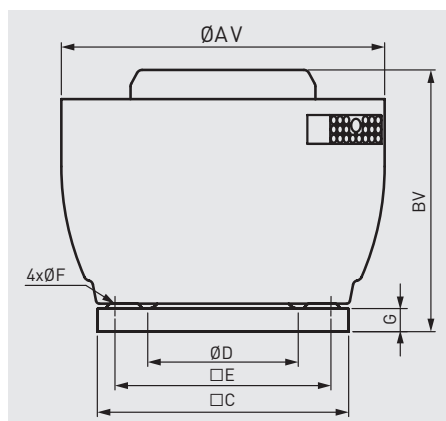

Fan model	AV	BV	□C	Ø D	□E	Ø F	G
180N	431	378	300	212	245	10	35
200N	560	415	435	234	330	12	40
225N	560	453	435	261	330	12	40
250N	750	504	560	289	450	12	40
315N	750	545	560	326	450	12	40
400N	857	605	630	420	535	12	40

CENTRIFUGAL ROOF MOUNTED FANS MAX-TEMP CTHB-N/CTHT-N Series - HORIZONTAL DISCHARGE



PERFORMANCE CURVES

- q_v : Airflow in m^3/h .
- p_{sf} : Static pressure in Pa.
- P: Input power in W.
- SFP: Specific Fan Power in $W/m^3/s$ (blue curves).
- Dry air at $20^\circ C$ and 760 mmHg.
- Performance data in accordance with ISO 5801 and AMCA 210-99 Standards.

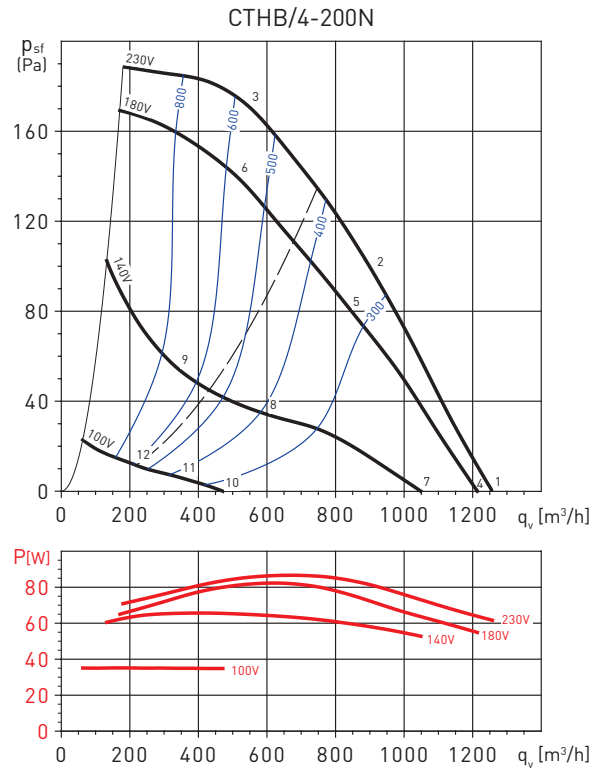
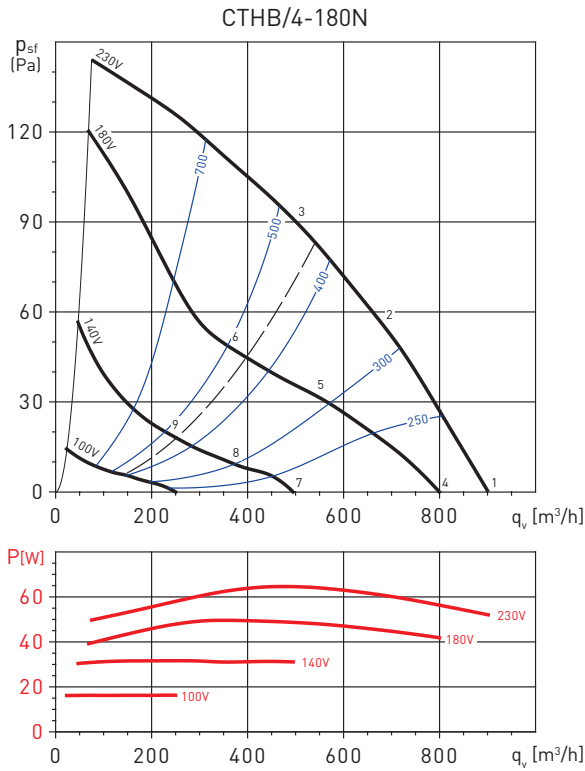

Sound power level spectrums in dB(A)

Working point		63	125	250	500	1000	2000	4000	8000	LwA
1	INLET	34	49	53	59	56	55	62	46	65
	OUTLET	35	49	56	61	63	62	64	48	69
2	INLET	34	46	52	57	54	53	55	43	62
	OUTLET	33	46	55	59	60	59	57	45	66
3	INLET	33	43	51	56	53	52	52	43	60
	OUTLET	30	44	52	58	59	58	53	44	64
4	INLET	31	46	51	56	53	53	60	44	63
	OUTLET	32	46	54	58	60	59	62	45	66
5	INLET	28	40	46	52	49	48	50	38	56
	OUTLET	27	41	49	54	55	54	51	40	60
6	INLET	27	37	44	50	46	45	45	36	54
	OUTLET	23	37	45	51	52	51	46	38	57
7	INLET	21	36	41	46	44	43	50	34	53
	OUTLET	22	36	44	49	50	49	52	35	56
8	INLET	18	30	36	41	38	38	39	28	46
	OUTLET	17	30	39	43	44	44	41	29	50
9	INLET	17	27	34	40	36	35	35	26	44
	OUTLET	13	27	35	41	42	41	36	28	47

Sound power level spectrums in dB(A)

Working point		63	125	250	500	1000	2000	4000	8000	LwA
1	INLET	33	49	57	59	58	58	64	46	67
	OUTLET	34	57	60	65	66	64	65	51	71
2	INLET	34	52	58	61	56	57	56	45	65
	OUTLET	36	55	60	65	64	63	59	50	70
3	INLET	37	50	57	61	56	58	56	46	65
	OUTLET	38	53	60	65	65	63	59	51	70
4	INLET	32	48	56	59	57	57	64	45	67
	OUTLET	34	56	59	64	65	63	64	50	71
5	INLET	32	50	57	59	54	55	54	43	63
	OUTLET	34	53	59	63	63	61	57	48	68
6	INLET	34	48	55	59	54	55	54	44	63
	OUTLET	36	51	58	62	62	61	57	48	68
7	INLET	29	45	53	56	54	54	61	42	63
	OUTLET	30	53	56	61	62	60	61	47	68
8	INLET	23	40	47	49	45	46	45	33	54
	OUTLET	24	43	49	53	53	51	48	38	59
9	INLET	25	38	46	49	44	46	44	34	53
	OUTLET	26	41	48	53	53	51	47	39	58
10	INLET	12	28	36	39	37	37	44	25	47
	OUTLET	14	36	39	44	45	43	44	30	51
11	INLET	8	26	32	34	30	31	30	19	39
	OUTLET	10	28	34	38	38	37	33	23	44
12	INLET	10	24	31	34	30	31	29	19	39
	OUTLET	11	26	33	38	38	37	33	24	43

CENTRIFUGAL ROOF MOUNTED FANS MAX-TEMP CTHB-N/CTHT-N Series - HORIZONTAL DISCHARGE



PERFORMANCE CURVES

- q_v : Airflow in m^3/h .
- p_{sf} : Static pressure in Pa.
- P: Input power in W.
- SFP: Specific Fan Power in $W/m^3/s$ (blue curves).
- Dry air at 20°C and 760 mmHg.
- Performance data in accordance with ISO 5801 and AMCA 210-99 Standards.

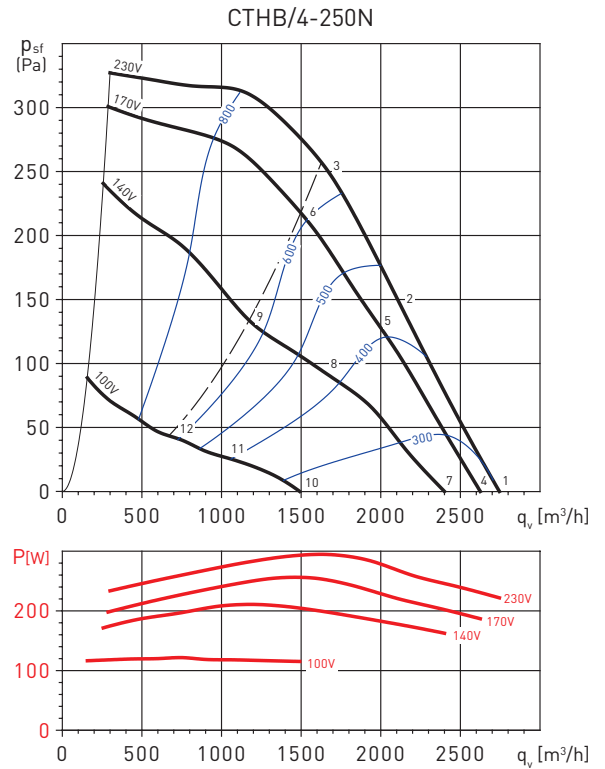
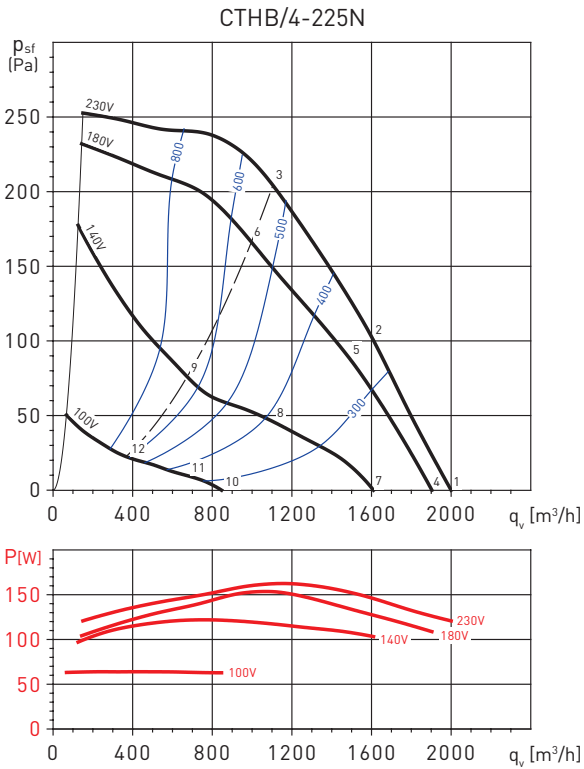

Sound power level spectrums in dB(A)

Working point		63	125	250	500	1000	2000	4000	8000	LwA
1	INLET	44	60	65	66	59	62	68	53	72
	OUTLET	43	63	67	71	69	67	69	58	76
2	INLET	44	57	63	64	58	60	59	47	69
	OUTLET	44	59	64	68	67	66	62	52	73
3	INLET	40	56	61	62	57	58	54	48	67
	OUTLET	40	59	62	66	65	64	59	52	71
4	INLET	43	59	64	65	58	61	67	52	71
	OUTLET	42	62	66	70	68	66	68	57	75
5	INLET	43	56	62	63	57	59	58	46	67
	OUTLET	43	58	63	67	66	65	61	51	72
6	INLET	38	54	59	60	55	56	52	46	64
	OUTLET	38	57	60	64	63	62	57	50	69
7	INLET	40	56	61	62	55	58	64	49	68
	OUTLET	39	59	63	67	65	63	65	54	72
8	INLET	36	49	55	56	50	52	51	39	61
	OUTLET	36	51	56	60	59	58	54	44	65
9	INLET	29	45	50	51	46	47	43	37	56
	OUTLET	29	48	51	55	54	53	48	41	60
10	INLET	26	42	47	48	41	44	50	35	54
	OUTLET	25	45	49	53	51	49	51	40	58
11	INLET	23	36	42	43	37	39	38	26	47
	OUTLET	23	38	43	47	46	45	41	31	52
12	INLET	16	32	37	38	33	34	30	24	43
	OUTLET	16	35	38	42	41	40	35	28	48

Sound power level spectrums in dB(A)

Working point		63	125	250	500	1000	2000	4000	8000	LwA
1	INLET	45	61	66	68	62	64	67	57	73
	OUTLET	47	65	71	74	72	70	68	61	79
2	INLET	46	59	63	65	61	63	59	47	70
	OUTLET	47	63	68	70	70	69	61	52	76
3	INLET	43	57	62	64	62	61	55	50	69
	OUTLET	44	61	66	70	70	67	61	54	75
4	INLET	44	61	65	67	61	63	66	56	73
	OUTLET	46	64	70	73	71	70	68	60	78
5	INLET	45	58	62	63	59	62	57	46	69
	OUTLET	46	61	67	69	68	68	60	51	74
6	INLET	41	55	60	62	60	59	54	48	67
	OUTLET	42	59	64	68	68	65	59	52	73
7	INLET	42	59	63	65	60	61	65	54	71
	OUTLET	44	63	68	71	69	68	66	58	76
8	INLET	41	54	58	60	56	58	54	42	65
	OUTLET	42	58	63	65	65	64	56	47	71
9	INLET	36	50	55	57	55	54	49	43	62
	OUTLET	37	54	59	63	63	60	54	47	68
10	INLET	32	48	53	55	49	51	54	44	60
	OUTLET	34	52	58	61	59	57	55	48	66
11	INLET	29	42	46	47	43	46	41	30	53
	OUTLET	30	45	51	53	52	52	44	35	58
12	INLET	24	38	43	45	43	42	36	31	50
	OUTLET	25	42	47	51	51	48	42	35	56

CENTRIFUGAL ROOF MOUNTED FANS MAX-TEMP CTHB-N/CTHT-N Series - HORIZONTAL DISCHARGE



PERFORMANCE CURVES

- q_v : Airflow in m^3/h .
- p_{sf} : Static pressure in Pa.
- P: Input power in W.
- SFP: Specific Fan Power in $W/m^3/s$ (blue curves).
- Dry air at $20^\circ C$ and 760 mmHg.
- Performance data in accordance with ISO 5801 and AMCA 210-99 Standards.

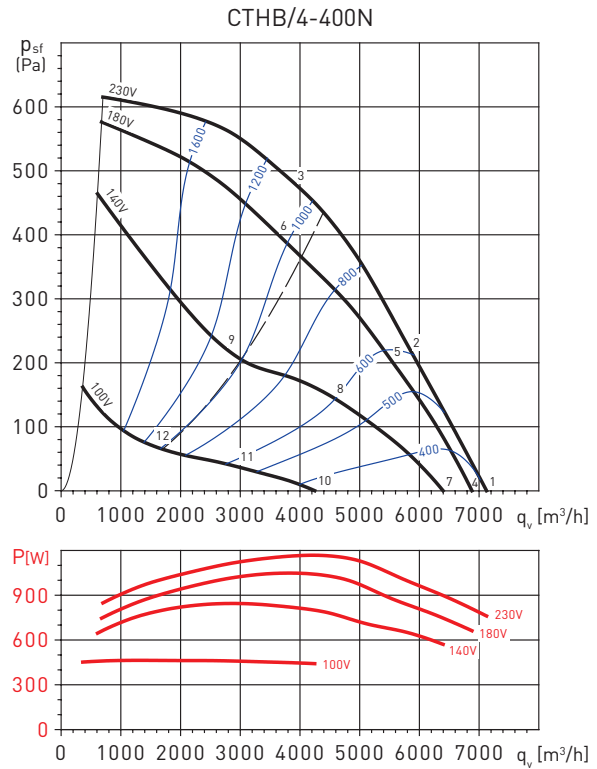
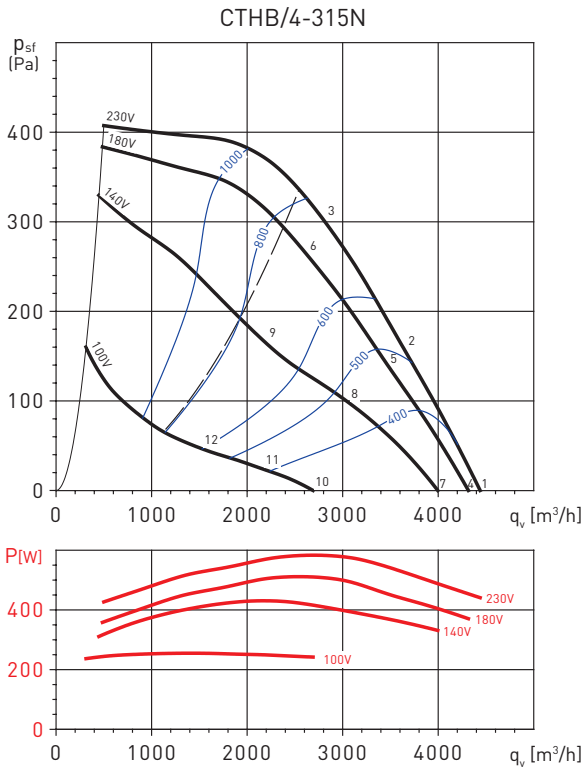

Sound power level spectrums in dB(A)

Working point		63	125	250	500	1000	2000	4000	8000	LwA
1	INLET	51	66	72	72	70	70	71	74	80
	OUTLET	53	70	77	79	77	75	75	73	84
2	INLET	51	64	72	71	69	68	68	69	78
	OUTLET	52	70	75	78	76	73	71	70	83
3	INLET	50	60	70	68	67	66	66	61	75
	OUTLET	52	68	72	76	73	70	69	64	80
4	INLET	50	66	71	71	70	69	70	73	79
	OUTLET	52	69	76	79	77	74	74	72	84
5	INLET	50	63	71	70	68	67	67	68	77
	OUTLET	51	69	74	76	75	72	70	69	82
6	INLET	49	59	68	66	65	64	65	60	73
	OUTLET	50	66	71	75	71	69	68	63	79
7	INLET	48	63	69	69	68	67	68	71	77
	OUTLET	50	67	74	76	75	72	72	70	82
8	INLET	46	59	67	66	64	63	63	64	73
	OUTLET	47	65	70	73	71	68	66	65	78
9	INLET	44	53	63	61	60	59	59	54	68
	OUTLET	45	61	65	70	66	64	63	58	74
10	INLET	37	52	58	58	56	56	57	60	66
	OUTLET	39	56	63	65	63	61	61	59	70
11	INLET	33	46	54	53	51	50	50	52	60
	OUTLET	34	52	58	60	58	55	53	52	65
12	INLET	31	41	51	49	48	47	47	42	56
	OUTLET	33	49	53	57	54	51	50	45	61

Sound power level spectrums in dB(A)

Working point		63	125	250	500	1000	2000	4000	8000	LwA
1	INLET	44	66	76	74	85	78	71	75	87
	OUTLET	47	75	77	86	90	85	76	77	93
2	INLET	42	62	76	72	81	71	67	67	83
	OUTLET	42	71	74	86	88	76	72	70	91
3	INLET	41	60	77	69	69	70	67	63	79
	OUTLET	43	70	73	83	78	73	74	68	85
4	INLET	43	65	75	73	84	77	70	74	86
	OUTLET	46	74	76	85	89	84	75	76	92
5	INLET	41	61	75	71	80	70	66	66	82
	OUTLET	41	70	73	85	87	75	71	69	89
6	INLET	39	58	75	67	67	68	65	61	77
	OUTLET	41	68	71	81	76	71	72	66	83
7	INLET	42	64	74	72	83	76	69	73	85
	OUTLET	45	73	75	84	88	83	74	75	91
8	INLET	37	57	71	67	76	66	62	62	78
	OUTLET	37	66	69	81	83	71	67	65	86
9	INLET	33	52	69	61	61	62	59	55	71
	OUTLET	35	62	65	75	70	65	66	60	77
10	INLET	33	55	65	63	74	67	60	64	76
	OUTLET	36	64	66	75	79	74	65	66	82
11	INLET	25	45	59	55	64	54	50	50	66
	OUTLET	25	54	57	69	71	59	55	53	73
12	INLET	20	39	56	48	48	49	46	42	59
	OUTLET	22	49	52	62	57	52	53	47	65



PERFORMANCE CURVES

- q_v : Airflow in m^3/h .
- p_{st} : Static pressure in Pa.
- P: Input power in W.
- SFP: Specific Fan Power in $W/m^3/s$ (blue curves).
- Dry air at 20°C and 760 mmHg.
- Performance data in accordance with ISO 5801 and AMCA 210-99 Standards.

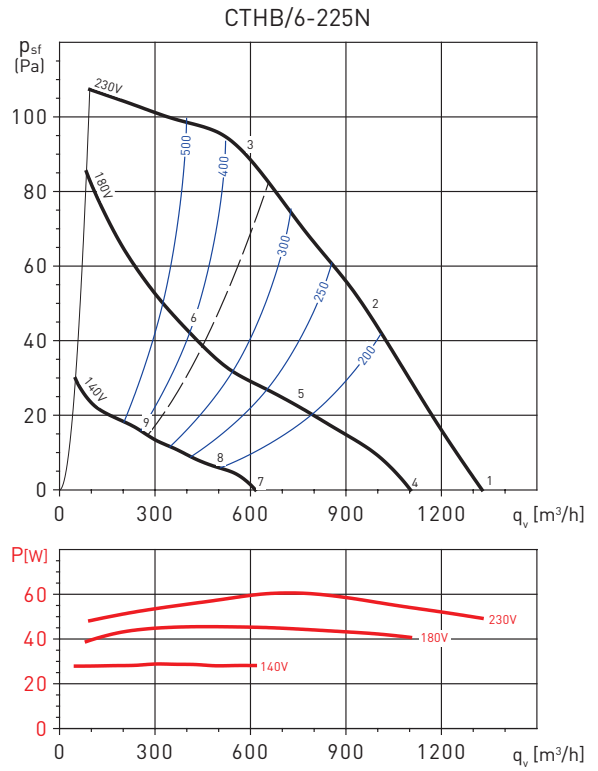
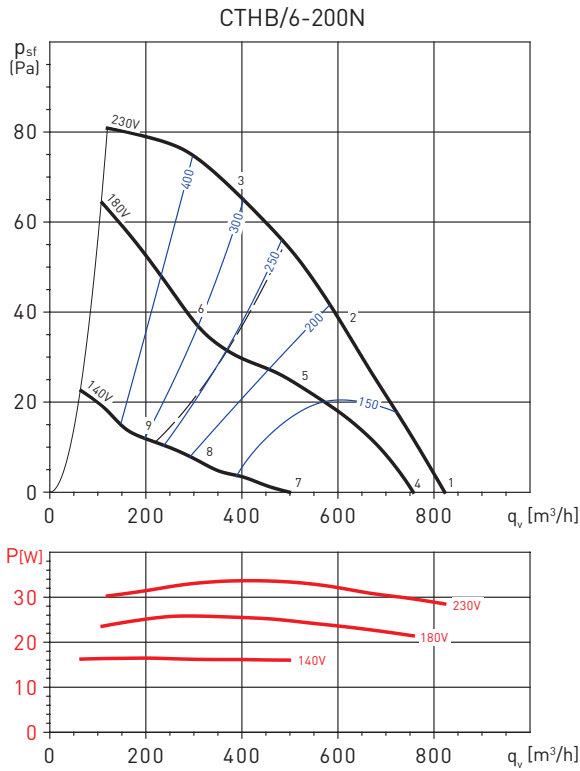

Sound power level spectrums in dB(A)

Working point		63	125	250	500	1000	2000	4000	8000	LwA
1	INLET	28	42	48	51	49	59	42	32	61
	OUTLET	32	45	51	56	56	59	45	35	63
2	INLET	33	42	49	50	48	50	42	32	56
	OUTLET	35	44	51	54	55	53	45	36	60
3	INLET	35	41	49	50	48	47	43	33	55
	OUTLET	36	43	50	54	55	53	45	36	60
4	INLET	27	41	46	49	47	58	40	30	59
	OUTLET	30	43	49	54	54	58	43	33	61
5	INLET	28	37	43	44	42	45	36	27	50
	OUTLET	29	38	45	49	49	48	40	30	54
6	INLET	30	36	44	44	43	42	38	28	50
	OUTLET	31	38	45	49	50	48	40	31	55
7	INLET	17	31	37	40	38	48	30	20	49
	OUTLET	21	34	40	45	45	48	34	23	51
8	INLET	16	25	32	32	30	33	25	15	38
	OUTLET	18	26	33	37	37	36	28	18	42
9	INLET	18	24	32	33	31	30	26	16	38
	OUTLET	20	26	33	38	38	36	29	19	43

Sound power level spectrums in dB(A)

Working point		63	125	250	500	1000	2000	4000	8000	LwA
1	INLET	41	47	52	53	49	59	56	33	62
	OUTLET	42	51	55	57	58	61	57	39	65
2	INLET	39	44	49	51	47	52	47	30	57
	OUTLET	40	47	51	55	56	54	49	35	61
3	INLET	34	41	47	47	44	47	41	31	53
	OUTLET	37	42	47	51	53	52	45	36	58
4	INLET	37	44	49	50	46	56	53	30	59
	OUTLET	39	48	51	54	55	57	54	36	62
5	INLET	32	37	42	44	40	45	40	23	50
	OUTLET	33	40	44	48	49	47	42	28	54
6	INLET	26	34	39	39	36	39	33	23	45
	OUTLET	29	34	39	43	45	44	37	28	50
7	INLET	25	31	37	37	33	44	40	17	47
	OUTLET	26	35	39	41	42	45	42	23	49
8	INLET	21	26	31	33	29	34	29	12	39
	OUTLET	22	29	33	37	38	36	31	17	43
9	INLET	16	23	29	29	26	29	23	12	35
	OUTLET	19	24	29	33	35	34	27	18	39

CENTRIFUGAL ROOF MOUNTED FANS MAX-TEMP CTHB-N/CTHT-N Series - HORIZONTAL DISCHARGE



PERFORMANCE CURVES

- q_v : Airflow in m^3/h .
- p_{sf} : Static pressure in Pa.
- P: Input power in W.
- SFP: Specific Fan Power in $W/m^3/s$ (blue curves).
- Dry air at $20^\circ C$ and 760 mmHg.
- Performance data in accordance with ISO 5801 and AMCA 210-99 Standards.

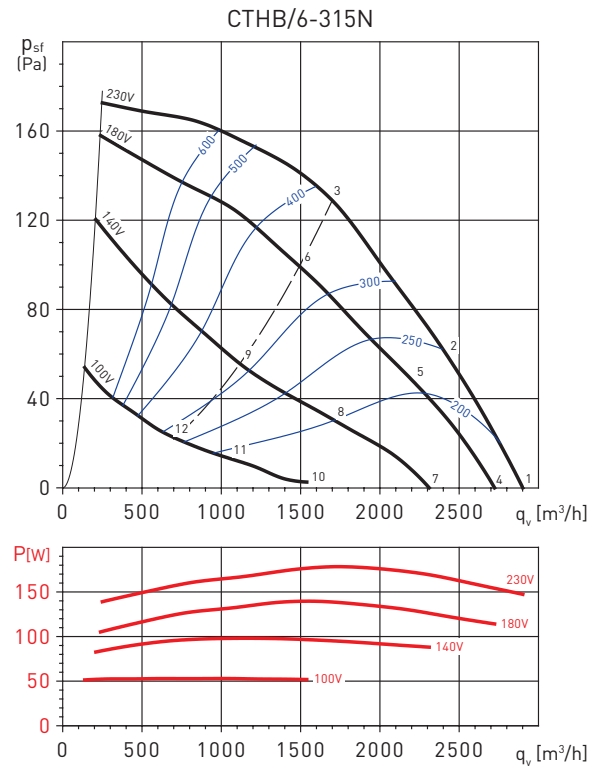
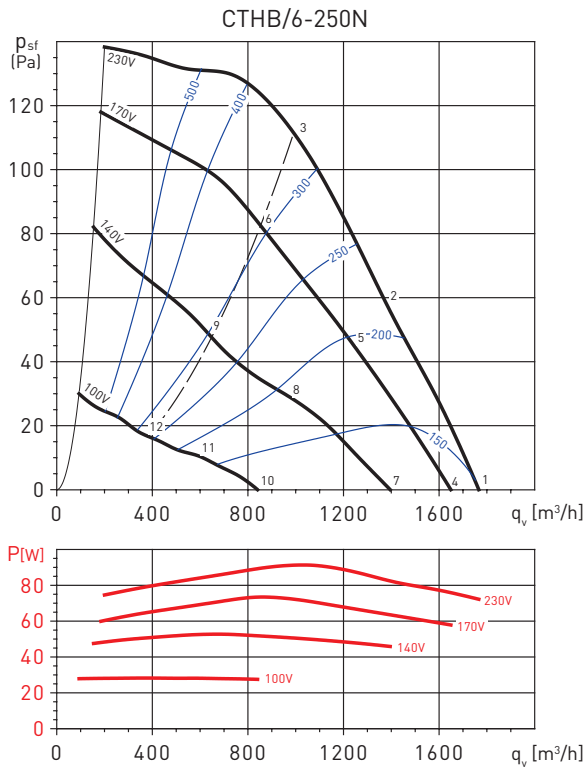

Sound power level spectrums in dB(A)

Working point		63	125	250	500	1000	2000	4000	8000	LwA
1	INLET	44	50	55	54	53	57	59	35	64
	OUTLET	46	54	59	61	63	61	58	42	68
2	INLET	43	48	53	52	51	53	52	32	60
	OUTLET	45	51	56	58	59	55	50	35	64
3	INLET	44	47	52	51	52	50	48	34	58
	OUTLET	43	49	55	58	59	56	49	39	64
4	INLET	43	49	54	53	52	56	58	34	62
	OUTLET	45	53	58	60	61	60	57	41	67
5	INLET	41	46	50	49	49	50	50	30	57
	OUTLET	43	48	54	56	57	53	48	32	62
6	INLET	41	43	49	48	49	47	44	31	55
	OUTLET	40	45	51	55	56	52	45	35	60
7	INLET	40	46	51	50	49	53	55	31	59
	OUTLET	42	50	55	57	59	57	54	38	64
8	INLET	34	39	43	42	42	43	43	23	50
	OUTLET	36	41	47	49	50	46	41	25	55
9	INLET	34	37	42	41	42	40	38	24	49
	OUTLET	33	39	45	48	49	46	39	29	54
10	INLET	29	36	41	39	38	42	44	20	49
	OUTLET	31	39	45	47	48	46	44	27	53
11	INLET	25	30	34	33	32	34	34	14	41
	OUTLET	27	32	37	40	41	37	32	16	46
12	INLET	23	25	31	30	30	29	26	13	37
	OUTLET	22	27	33	37	37	34	27	17	42

Sound power level spectrums in dB(A)

Working point		63	125	250	500	1000	2000	4000	8000	LwA
1	INLET	44	54	60	59	59	61	64	45	68
	OUTLET	47	58	64	66	65	66	64	50	72
2	INLET	45	54	60	59	58	60	61	44	67
	OUTLET	48	56	63	65	65	63	62	50	71
3	INLET	44	52	57	55	56	58	56	43	64
	OUTLET	46	53	60	62	62	61	58	48	68
4	INLET	43	53	60	59	58	61	64	45	68
	OUTLET	46	57	64	66	65	65	64	50	72
5	INLET	43	52	58	57	56	57	59	42	65
	OUTLET	45	54	61	63	62	61	60	48	69
6	INLET	41	49	54	53	54	56	54	40	61
	OUTLET	44	50	57	59	59	58	55	45	65
7	INLET	40	50	56	56	55	57	60	41	64
	OUTLET	43	54	60	62	61	62	60	46	68
8	INLET	38	47	53	51	51	52	54	37	60
	OUTLET	40	49	56	58	57	56	55	42	64
9	INLET	35	43	48	47	48	50	47	34	55
	OUTLET	37	44	51	53	53	52	49	39	59
10	INLET	30	40	47	46	45	48	51	32	55
	OUTLET	33	44	51	53	52	52	51	37	59
11	INLET	28	37	43	41	41	42	44	26	50
	OUTLET	30	39	46	48	47	46	45	32	54
12	INLET	24	32	37	36	37	39	37	23	45
	OUTLET	27	33	41	43	42	41	38	28	48

CENTRIFUGAL ROOF MOUNTED FANS MAX-TEMP CTHB-N/CTHT-N Series - HORIZONTAL DISCHARGE



PERFORMANCE CURVES

- q_v : Airflow in m^3/h .
- p_{sf} : Static pressure in Pa.
- P: Input power in W.
- SFP: Specific Fan Power in $W/m^3/s$ (blue curves).
- Dry air at 20°C and 760 mmHg.
- Performance data in accordance with ISO 5801 and AMCA 210-99 Standards.

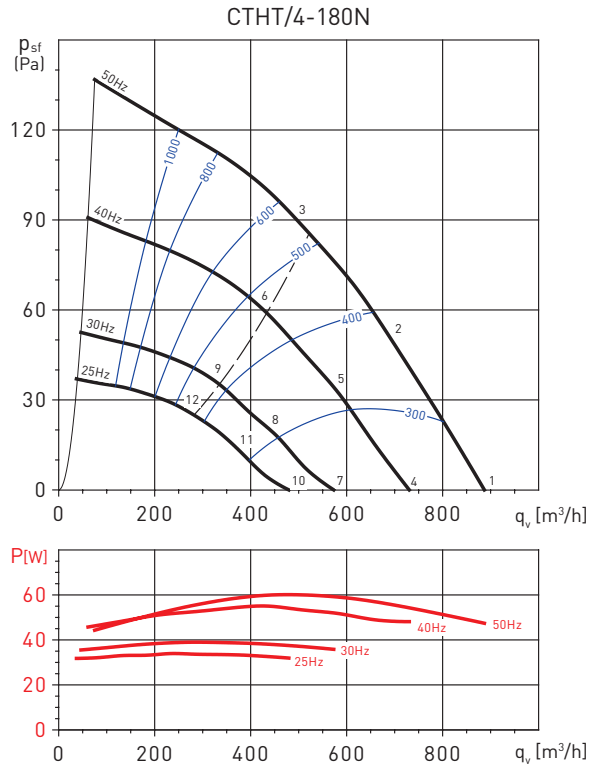
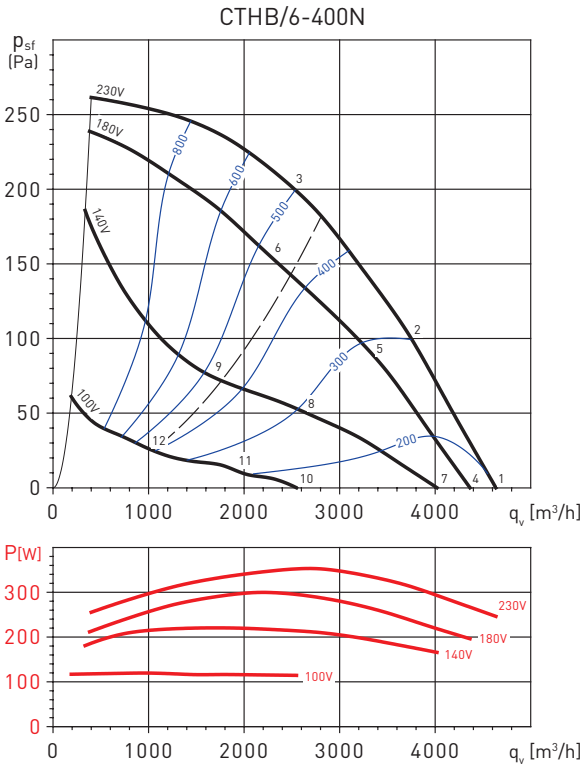

Sound power level spectrums in dB(A)

Working point		63	125	250	500	1000	2000	4000	8000	LwA
1	INLET	43	53	63	67	72	62	71	53	76
	OUTLET	45	60	68	76	81	66	72	56	83
2	INLET	43	53	61	67	66	60	67	50	72
	OUTLET	46	57	68	75	74	64	66	53	78
3	INLET	44	55	61	60	59	60	60	49	67
	OUTLET	49	56	65	68	64	64	63	53	72
4	INLET	42	52	62	66	71	61	70	52	75
	OUTLET	44	59	67	75	80	65	71	55	82
5	INLET	42	52	60	66	65	59	66	49	71
	OUTLET	45	56	67	74	73	63	65	52	77
6	INLET	42	53	59	58	57	58	58	47	65
	OUTLET	47	54	63	66	62	62	61	51	70
7	INLET	40	50	60	64	69	59	68	50	73
	OUTLET	42	57	65	73	78	63	69	53	80
8	INLET	36	46	54	60	59	53	60	43	65
	OUTLET	39	50	61	68	67	57	59	46	71
9	INLET	34	45	51	50	49	50	50	39	57
	OUTLET	39	46	55	58	54	54	53	43	62
10	INLET	30	40	50	54	59	49	58	40	63
	OUTLET	32	47	55	63	68	53	59	43	70
11	INLET	24	34	42	48	47	41	48	31	53
	OUTLET	27	38	49	56	55	45	47	34	59
12	INLET	23	34	40	39	38	39	39	28	46
	OUTLET	28	35	44	47	43	43	42	32	51

Sound power level spectrums in dB(A)

Working point		63	125	250	500	1000	2000	4000	8000	LwA
1	INLET	33	48	53	58	56	55	62	46	65
	OUTLET	34	48	56	61	62	61	64	48	68
2	INLET	33	45	51	57	54	53	55	43	61
	OUTLET	32	46	54	59	60	59	56	45	65
3	INLET	33	43	51	56	53	52	52	43	60
	OUTLET	30	44	52	58	59	58	53	45	64
4	INLET	29	44	48	54	51	51	58	41	61
	OUTLET	30	44	51	56	58	57	59	43	64
5	INLET	29	41	47	53	49	49	51	39	57
	OUTLET	28	41	50	55	56	55	52	41	61
6	INLET	29	39	47	52	49	48	48	39	56
	OUTLET	26	40	48	54	55	54	49	40	60
7	INLET	23	38	43	48	46	45	52	36	55
	OUTLET	24	38	46	50	52	51	54	37	58
8	INLET	23	36	41	47	44	43	45	33	52
	OUTLET	23	36	44	49	50	49	47	35	55
9	INLET	24	34	41	47	43	42	42	33	51
	OUTLET	20	34	43	48	49	48	43	35	54
10	INLET	19	34	39	44	42	41	48	32	51
	OUTLET	20	34	42	47	48	47	50	34	54
11	INLET	20	32	38	43	40	40	41	30	48
	OUTLET	19	32	41	45	46	46	43	31	52
12	INLET	20	30	37	43	40	39	38	29	47
	OUTLET	16	30	39	45	46	45	40	31	51

CENTRIFUGAL ROOF MOUNTED FANS MAX-TEMP CTHB-N/CTHT-N Series - HORIZONTAL DISCHARGE



PERFORMANCE CURVES

- q_v : Airflow in m^3/h .
- p_{sf} : Static pressure in Pa.
- P: Input power in W.
- SFP: Specific Fan Power in $W/m^3/s$ (blue curves).
- Dry air at $20^\circ C$ and 760 mmHg .
- Performance data in accordance with ISO 5801 and AMCA 210-99 Standards.

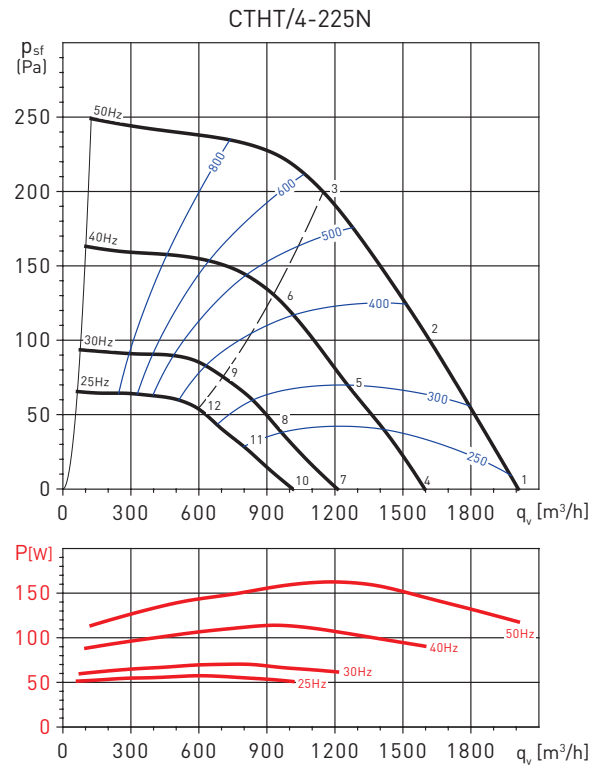
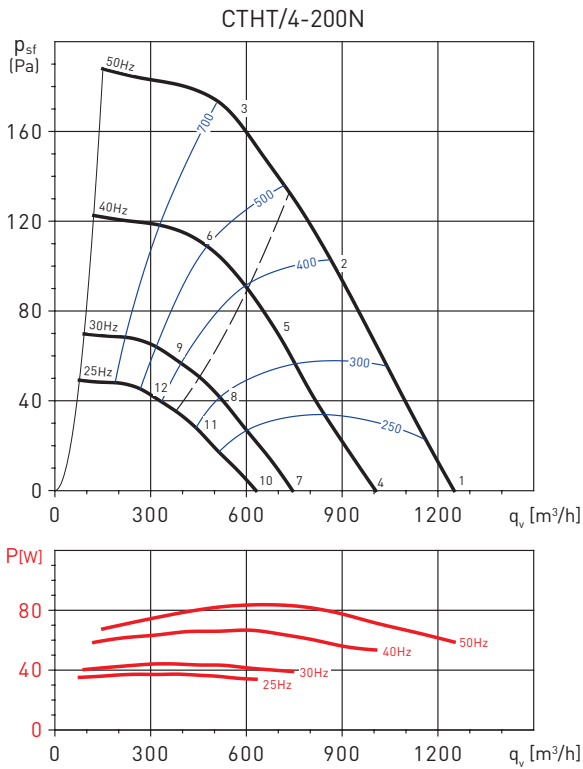

Sound power level spectrums in dB(A)

Working point		63	125	250	500	1000	2000	4000	8000	LwA
1	INLET	32	49	57	59	57	58	64	45	67
	OUTLET	34	57	60	65	65	64	65	51	71
2	INLET	34	52	58	60	56	57	56	45	65
	OUTLET	36	54	60	65	64	63	59	49	70
3	INLET	36	50	57	60	56	57	56	46	65
	OUTLET	38	52	60	64	64	63	59	50	70
4	INLET	28	44	52	55	53	53	60	41	63
	OUTLET	30	52	55	60	61	59	60	46	67
5	INLET	30	47	54	56	52	52	52	40	61
	OUTLET	31	50	56	60	60	58	54	45	65
6	INLET	32	45	53	56	52	53	51	41	60
	OUTLET	33	48	55	60	60	59	54	46	65
7	INLET	22	38	46	48	47	47	53	35	56
	OUTLET	23	46	49	54	55	53	54	40	60
8	INLET	24	41	48	50	46	46	46	34	55
	OUTLET	25	44	50	54	54	52	48	39	59
9	INLET	26	40	47	50	46	47	45	35	55
	OUTLET	27	42	49	54	54	53	48	40	59
10	INLET	18	34	42	45	43	43	50	31	53
	OUTLET	20	42	45	50	51	49	50	36	57
11	INLET	20	37	44	46	42	43	42	30	51
	OUTLET	21	40	46	50	50	49	45	35	56
12	INLET	22	36	43	46	42	43	42	31	51
	OUTLET	24	38	45	50	50	49	45	36	56

Sound power level spectrums in dB(A)

Working point		63	125	250	500	1000	2000	4000	8000	LwA
1	INLET	42	63	65	65	60	63	68	53	73
	OUTLET	46	63	67	71	70	68	70	58	77
2	INLET	44	57	63	63	58	60	61	45	69
	OUTLET	44	59	63	67	67	65	63	50	73
3	INLET	42	55	60	61	57	58	57	45	66
	OUTLET	41	57	61	65	66	63	60	50	71
4	INLET	37	58	60	60	55	58	63	48	68
	OUTLET	41	58	62	66	65	63	65	53	72
5	INLET	39	52	58	58	53	55	56	40	64
	OUTLET	39	54	58	62	62	60	58	45	68
6	INLET	38	51	56	57	53	54	53	41	62
	OUTLET	37	53	57	61	62	59	56	46	66
7	INLET	31	52	54	54	49	52	57	42	62
	OUTLET	35	52	56	60	59	57	59	47	66
8	INLET	34	47	53	53	48	50	51	35	58
	OUTLET	34	49	53	57	57	55	53	40	62
9	INLET	32	45	50	51	47	48	47	35	56
	OUTLET	31	47	51	55	56	53	50	40	60
10	INLET	28	49	51	51	46	49	54	39	58
	OUTLET	32	49	53	57	56	54	56	44	62
11	INLET	30	43	49	49	44	46	47	31	54
	OUTLET	30	45	49	53	53	51	49	36	58
12	INLET	28	41	46	47	43	44	43	31	52
	OUTLET	27	43	47	51	52	49	46	36	57

CENTRIFUGAL ROOF MOUNTED FANS MAX-TEMP CTHB-N/CTHT-N Series - HORIZONTAL DISCHARGE



PERFORMANCE CURVES

- q_v : Airflow in m^3/h .
- p_{sf} : Static pressure in Pa.
- P: Input power in W.
- SFP: Specific Fan Power in $W/m^3/s$ (blue curves).
- Dry air at 20°C and 760 mmHg.
- Performance data in accordance with ISO 5801 and AMCA 210-99 Standards.

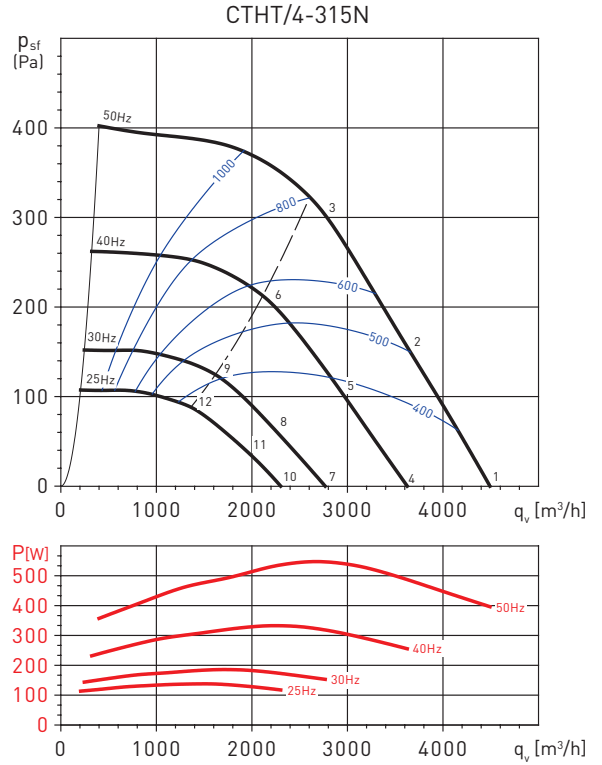
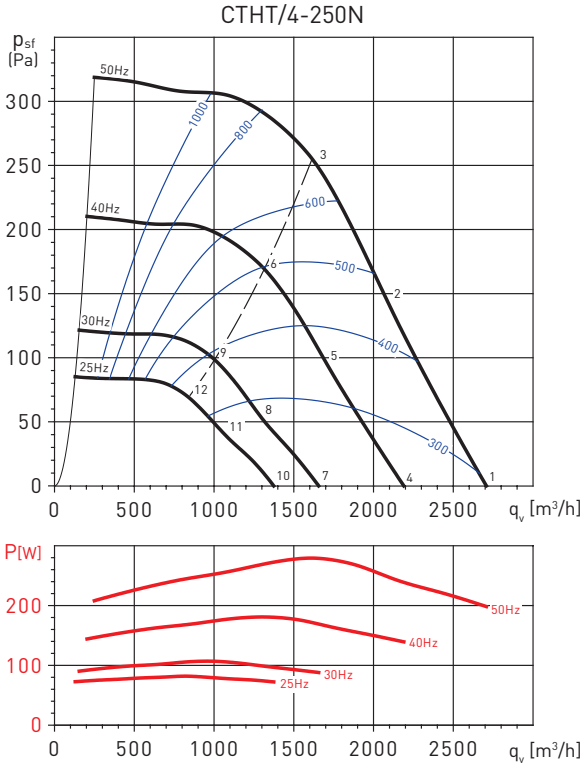

Sound power level spectrums in dB(A)

Working point		63	125	250	500	1000	2000	4000	8000	LwA
1	INLET	45	61	66	68	62	64	67	57	73
	OUTLET	47	65	71	74	72	70	68	61	79
2	INLET	46	59	63	65	61	63	59	47	70
	OUTLET	47	63	68	70	70	69	61	52	76
3	INLET	43	57	62	64	62	61	55	50	69
	OUTLET	44	61	66	70	70	67	61	54	75
4	INLET	40	57	62	63	58	59	63	53	69
	OUTLET	42	61	67	69	67	66	64	56	74
5	INLET	42	54	59	60	56	59	54	43	66
	OUTLET	43	58	63	66	65	65	57	48	71
6	INLET	39	53	58	60	57	56	51	45	64
	OUTLET	39	57	62	65	65	63	56	49	70
7	INLET	34	51	56	57	52	53	57	47	63
	OUTLET	36	55	60	63	61	60	58	50	68
8	INLET	36	49	53	54	50	53	48	37	60
	OUTLET	37	52	58	60	59	59	51	42	65
9	INLET	33	47	52	54	51	51	45	39	59
	OUTLET	34	51	56	59	59	57	51	43	65
10	INLET	30	47	52	53	48	50	53	43	59
	OUTLET	32	51	57	59	58	56	54	46	64
11	INLET	32	45	49	51	47	49	45	33	56
	OUTLET	33	49	54	56	55	55	47	38	62
12	INLET	29	43	48	50	48	47	41	36	55
	OUTLET	30	47	52	56	56	53	47	40	61

Sound power level spectrums in dB(A)

Working point		63	125	250	500	1000	2000	4000	8000	LwA
1	INLET	51	66	71	72	70	70	71	74	79
	OUTLET	52	70	77	79	77	75	75	73	84
2	INLET	51	64	72	71	69	68	68	69	78
	OUTLET	52	70	75	77	76	73	71	70	83
3	INLET	50	60	70	67	66	65	66	61	75
	OUTLET	51	68	72	76	73	70	69	64	80
4	INLET	46	62	67	67	66	65	66	69	75
	OUTLET	48	65	72	75	73	70	70	68	80
5	INLET	46	60	67	66	65	63	63	65	73
	OUTLET	48	66	71	73	71	68	67	66	78
6	INLET	46	55	65	63	62	61	62	57	70
	OUTLET	47	63	68	72	68	66	65	60	76
7	INLET	40	56	61	61	60	59	60	63	69
	OUTLET	42	59	66	69	67	64	64	62	74
8	INLET	40	54	62	60	59	57	57	59	67
	OUTLET	42	60	65	67	65	62	61	60	72
9	INLET	40	50	59	57	56	55	56	51	64
	OUTLET	41	57	62	66	62	60	59	54	70
10	INLET	36	52	57	57	56	55	56	59	65
	OUTLET	38	55	62	65	63	60	60	59	70
11	INLET	36	50	58	56	55	54	53	55	63
	OUTLET	38	56	61	63	62	59	57	56	68
12	INLET	36	46	56	53	52	51	52	47	61
	OUTLET	37	54	58	62	59	56	55	50	66

PERFORMANCE CURVES

- q_v : Airflow in m^3/h .
- p_{sf} : Static pressure in Pa.
- P: Input power in W.
- SFP: Specific Fan Power in $W/m^3/s$ (blue curves).
- Dry air at 20°C and 760 mmHg.
- Performance data in accordance with ISO 5801 and AMCA 210-99 Standards.

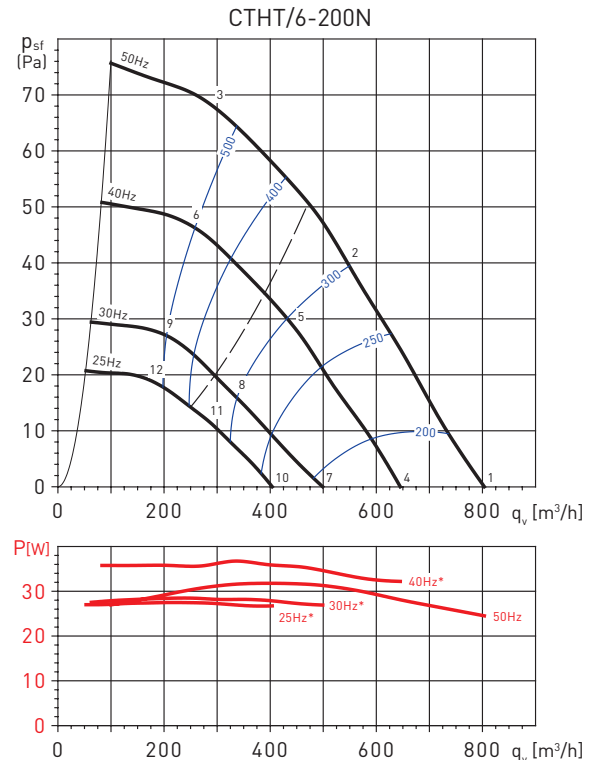
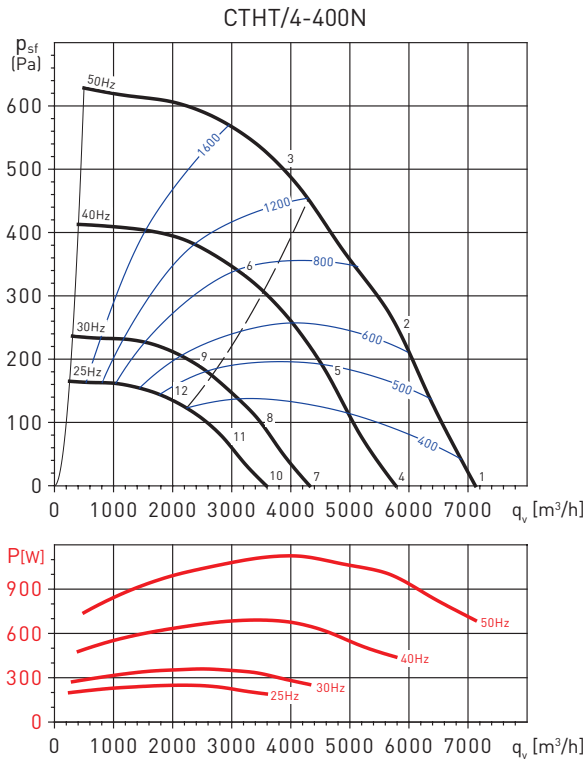

Sound power level spectrums in dB(A)

Working point		63	125	250	500	1000	2000	4000	8000	LwA
1	INLET	45	66	76	73	85	77	68	76	87
	OUTLET	48	75	77	87	90	86	74	79	93
2	INLET	42	64	76	72	80	70	66	66	82
	OUTLET	42	72	75	87	88	76	72	70	91
3	INLET	46	63	78	69	68	70	69	64	80
	OUTLET	44	71	73	84	79	73	73	69	86
4	INLET	40	61	71	68	80	72	63	71	82
	OUTLET	43	70	72	82	85	81	69	74	89
5	INLET	38	60	72	68	76	66	62	62	78
	OUTLET	38	68	71	83	84	72	68	66	87
6	INLET	42	59	74	65	64	66	65	60	76
	OUTLET	40	67	69	80	75	69	69	65	82
7	INLET	34	55	65	62	74	66	57	65	76
	OUTLET	37	64	66	76	79	75	63	68	82
8	INLET	32	54	66	62	70	60	56	56	72
	OUTLET	32	62	65	77	78	66	62	60	81
9	INLET	36	53	68	59	58	60	59	54	70
	OUTLET	34	61	63	74	69	63	63	59	76
10	INLET	30	51	61	58	70	62	53	61	72
	OUTLET	33	60	62	72	75	71	59	64	79
11	INLET	28	50	62	58	66	56	52	52	68
	OUTLET	28	58	61	73	74	62	58	56	77
12	INLET	32	49	64	55	54	56	55	50	66
	OUTLET	30	57	59	70	65	59	59	55	72

Sound power level spectrums in dB(A)

Working point		63	125	250	500	1000	2000	4000	8000	LwA
1	INLET	33	47	54	61	56	55	60	45	65
	OUTLET	35	48	56	65	62	61	62	47	69
2	INLET	34	47	53	60	55	54	53	44	63
	OUTLET	34	45	55	62	61	60	54	46	66
3	INLET	42	47	53	60	55	54	51	44	63
	OUTLET	43	48	55	63	62	61	55	47	67
4	INLET	31	45	52	59	54	52	58	43	63
	OUTLET	33	46	54	63	60	59	60	45	67
5	INLET	29	42	49	55	51	49	48	40	58
	OUTLET	30	40	50	57	56	55	50	41	61
6	INLET	38	43	48	56	51	50	47	40	59
	OUTLET	39	43	51	59	57	57	51	42	63
7	INLET	24	38	45	52	47	46	51	37	56
	OUTLET	26	39	48	56	53	53	53	38	60
8	INLET	20	34	40	46	42	40	39	31	49
	OUTLET	21	31	41	48	47	46	41	32	53
9	INLET	30	34	40	47	43	41	39	32	50
	OUTLET	30	35	42	50	49	48	42	34	54
10	INLET	10	24	31	37	32	31	36	22	42
	OUTLET	12	24	33	42	39	38	39	24	46
11	INLET	9	22	29	35	30	29	28	19	38
	OUTLET	10	20	30	37	36	35	29	21	41
12	INLET	19	23	29	36	32	30	28	21	39
	OUTLET	19	24	32	39	38	37	31	23	44

CENTRIFUGAL ROOF MOUNTED FANS MAX-TEMP CTHB-N/CTHT-N Series - HORIZONTAL DISCHARGE



PERFORMANCE CURVES

- q_v : Airflow in m^3/h .
- p_{sf} : Static pressure in Pa.
- P: Input power in W.
- SFP: Specific Fan Power in $W/m^3/s$ (blue curves).
- Dry air at 20°C and 760 mmHg.
- Performance data in accordance with ISO 5801 and AMCA 210-99 Standards.

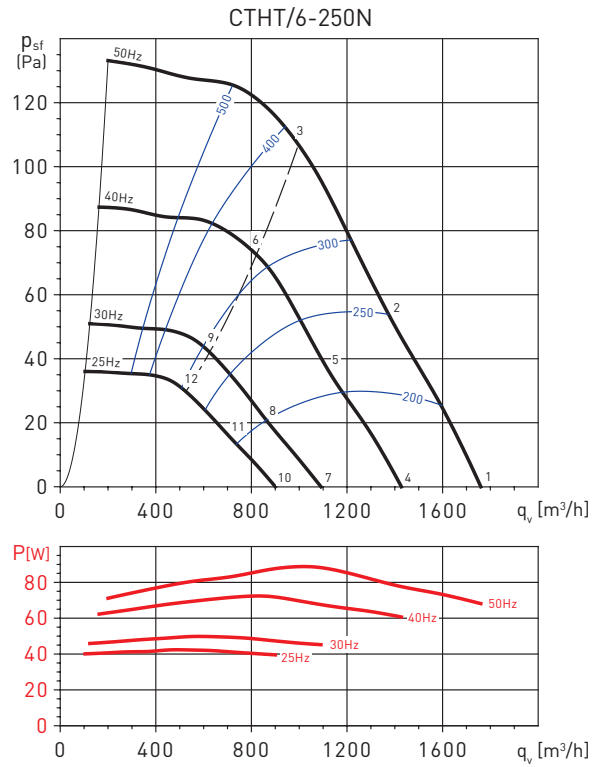
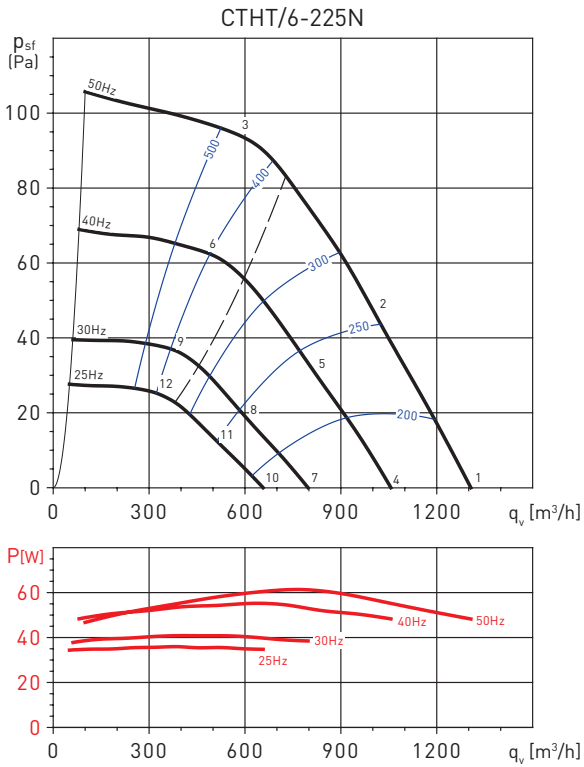

Sound power level spectrums in dB(A)

Working point		63	125	250	500	1000	2000	4000	8000	LwA
1	INLET	41	47	52	53	49	59	56	33	62
	OUTLET	42	51	55	57	58	60	57	39	65
2	INLET	39	45	49	51	48	53	47	30	57
	OUTLET	40	47	51	55	56	54	49	36	61
3	INLET	34	42	47	47	45	48	41	31	53
	OUTLET	38	43	47	51	53	53	45	36	58
4	INLET	36	43	48	48	44	55	51	30	58
	OUTLET	37	47	50	53	53	56	53	34	61
5	INLET	35	40	45	46	43	48	43	30	53
	OUTLET	36	43	47	50	52	50	45	31	57
6	INLET	30	37	43	43	40	43	37	30	49
	OUTLET	33	38	43	47	49	48	41	32	54
7	INLET	30	37	42	42	38	49	45	30	52
	OUTLET	31	41	44	47	47	50	47	30	55
8	INLET	30	34	39	41	37	42	37	30	47
	OUTLET	30	37	41	45	46	44	39	30	51
9	INLET	30	32	37	37	34	37	31	30	44
	OUTLET	30	32	37	41	43	43	35	30	48
10	INLET	30	33	38	38	34	45	41	30	48
	OUTLET	30	37	40	43	43	46	43	30	51
11	INLET	35	40	45	46	43	48	43	35	53
	OUTLET	36	42	47	50	51	50	44	35	56
12	INLET	35	37	42	42	40	43	37	35	49
	OUTLET	35	38	43	46	48	48	40	35	53

Sound power level spectrums in dB(A)

Working point		63	125	250	500	1000	2000	4000	8000	LwA
1	INLET	43	50	55	53	52	56	58	34	63
	OUTLET	45	53	59	61	62	60	58	42	67
2	INLET	43	48	52	51	50	52	52	31	59
	OUTLET	45	50	55	58	59	55	50	34	63
3	INLET	44	46	52	51	51	50	47	34	58
	OUTLET	43	48	54	58	58	55	48	38	63
4	INLET	39	45	50	49	48	52	54	30	58
	OUTLET	41	49	54	56	57	56	53	37	63
5	INLET	38	43	48	47	46	48	47	27	55
	OUTLET	40	46	51	53	55	50	45	30	59
6	INLET	39	42	47	47	47	45	43	29	54
	OUTLET	38	44	50	53	54	51	44	34	59
7	INLET	33	39	44	43	42	46	48	24	52
	OUTLET	35	43	48	50	52	50	47	31	57
8	INLET	33	38	42	41	40	42	42	21	49
	OUTLET	35	40	45	48	49	45	40	24	53
9	INLET	34	36	42	41	41	40	37	24	48
	OUTLET	33	38	44	48	48	45	38	28	53
10	INLET	29	36	41	39	38	42	44	20	49
	OUTLET	31	39	45	47	48	46	44	27	53
11	INLET	29	34	38	37	36	38	38	17	45
	OUTLET	31	36	41	44	45	41	36	20	50
12	INLET	30	33	38	37	38	36	34	20	44
	OUTLET	29	34	41	44	45	42	35	24	49

PERFORMANCE CURVES

- q_v : Airflow in m^3/h .
- p_{sf} : Static pressure in Pa.
- P: Input power in W.
- SFP: Specific Fan Power in $W/m^3/s$ (blue curves).
- Dry air at 20°C and 760 mmHg.
- Performance data in accordance with ISO 5801 and AMCA 210-99 Standards.

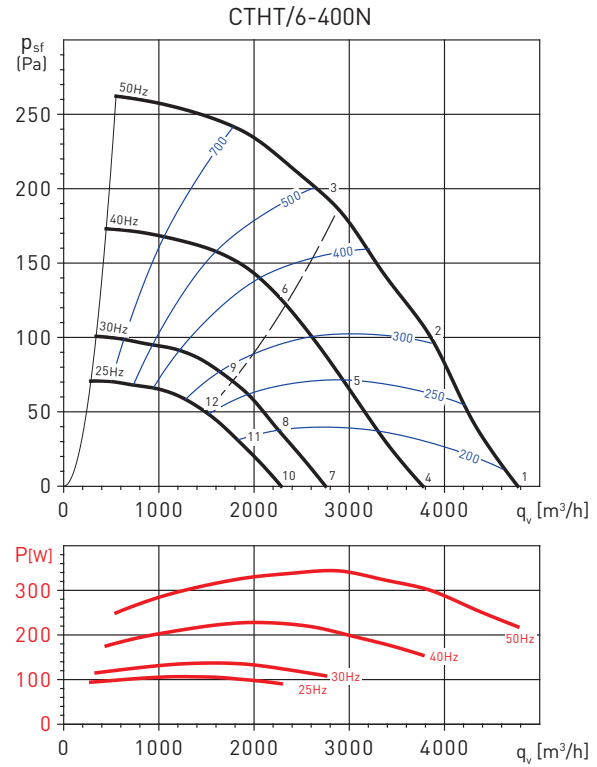
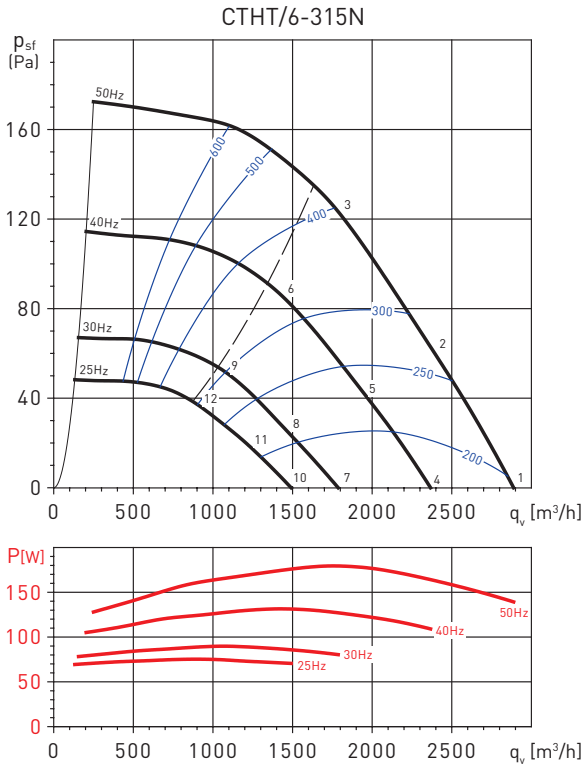

Sound power level spectrums in dB(A)

Working point		63	125	250	500	1000	2000	4000	8000	LwA
1	INLET	45	55	61	60	60	62	65	46	69
	OUTLET	48	59	65	67	66	67	65	51	73
2	INLET	45	54	60	59	58	59	61	44	67
	OUTLET	47	56	63	65	65	63	62	50	71
3	INLET	44	52	57	56	57	59	56	43	64
	OUTLET	47	53	60	62	62	61	58	48	68
4	INLET	40	50	57	56	55	57	61	42	65
	OUTLET	43	54	60	63	62	62	61	47	69
5	INLET	41	49	56	54	54	55	57	39	63
	OUTLET	43	52	59	61	60	59	57	45	67
6	INLET	40	48	53	51	52	54	52	39	60
	OUTLET	42	49	56	58	58	57	54	44	64
7	INLET	34	44	51	50	49	52	55	36	59
	OUTLET	37	48	55	57	56	56	55	41	63
8	INLET	35	44	50	48	48	49	51	34	57
	OUTLET	37	46	53	55	54	53	52	39	61
9	INLET	34	42	47	46	47	49	46	33	54
	OUTLET	36	43	50	52	52	51	48	38	58
10	INLET	31	40	47	46	45	48	51	32	55
	OUTLET	34	44	51	53	52	53	51	37	59
11	INLET	31	40	46	45	44	46	47	30	53
	OUTLET	34	43	49	51	51	49	48	36	57
12	INLET	30	38	43	42	43	45	43	29	50
	OUTLET	33	39	47	48	48	47	44	34	54

Sound power level spectrums in dB(A)

Working point		63	125	250	500	1000	2000	4000	8000	LwA
1	INLET	41	53	63	67	73	62	71	56	76
	OUTLET	44	61	69	76	81	67	72	59	83
2	INLET	40	52	63	67	67	60	66	50	72
	OUTLET	43	58	68	75	75	65	67	54	79
3	INLET	38	52	61	62	59	59	61	49	68
	OUTLET	45	56	66	69	65	65	64	54	73
4	INLET	36	48	58	62	68	57	66	51	72
	OUTLET	39	56	64	71	76	62	67	54	78
5	INLET	36	48	59	63	63	56	62	46	68
	OUTLET	39	54	64	71	71	61	63	50	75
6	INLET	34	48	57	58	55	55	57	45	63
	OUTLET	41	52	62	65	61	61	60	50	69
7	INLET	30	42	52	56	62	51	60	45	66
	OUTLET	33	50	58	65	70	56	61	48	72
8	INLET	30	42	53	57	57	50	56	40	62
	OUTLET	33	48	58	65	65	55	57	44	69
9	INLET	28	42	51	52	49	49	51	39	57
	OUTLET	35	46	56	59	55	55	54	44	63
10	INLET	26	38	48	52	58	47	56	41	62
	OUTLET	29	46	54	61	66	52	57	44	68
11	INLET	26	38	49	53	53	46	52	36	58
	OUTLET	29	44	54	61	61	51	53	40	65
12	INLET	24	38	47	48	45	45	47	35	54
	OUTLET	31	42	52	55	51	51	50	40	59



PERFORMANCE CURVES

- q_v : Airflow in m^3/h .
- p_{sf} : Static pressure in Pa.
- P: Input power in W.
- SFP: Specific Fan Power in $W/m^3/s$ (blue curves).
- Dry air at 20°C and 760 mmHg.
- Performance data in accordance with ISO 5801 and AMCA 210-99 Standards.

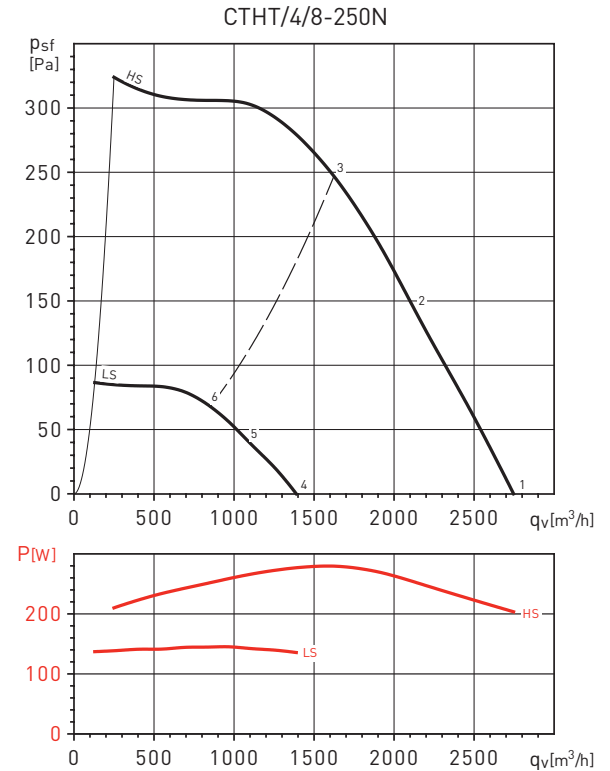
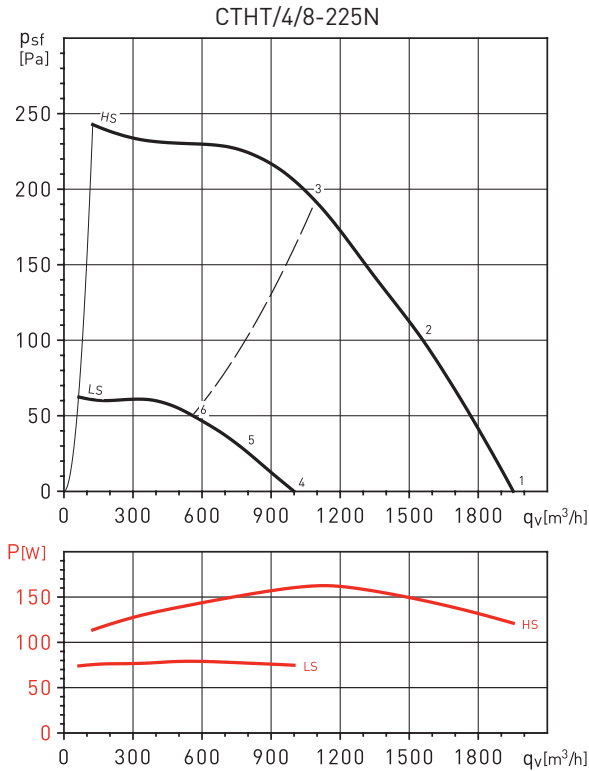

Sound power level spectrums in dB(A)

Working point		63	125	250	500	1000	2000	4000	8000	LwA
1	INLET	42	63	65	65	60	63	68	53	72
	OUTLET	46	63	67	71	70	68	70	58	76
2	INLET	44	57	63	63	58	60	61	45	68
	OUTLET	44	59	63	67	67	65	63	50	72
3	INLET	42	55	60	61	57	58	57	45	66
	OUTLET	41	57	61	65	66	63	60	50	70
4	INLET	27	48	50	50	45	48	53	38	58
	OUTLET	31	48	52	56	55	53	55	43	62
5	INLET	29	42	48	48	43	45	46	30	54
	OUTLET	29	44	48	52	52	50	48	35	58
6	INLET	27	40	45	46	42	43	42	30	52
	OUTLET	26	42	46	50	51	48	45	35	56

Sound power level spectrums in dB(A)

Working point		63	125	250	500	1000	2000	4000	8000	LwA
1	INLET	45	61	66	68	62	64	67	57	73
	OUTLET	47	65	71	74	72	70	68	61	79
2	INLET	46	59	63	65	61	63	59	47	70
	OUTLET	47	63	68	70	69	69	61	52	76
3	INLET	43	57	62	64	62	61	55	50	69
	OUTLET	44	61	66	70	70	67	61	54	75
4	INLET	30	47	52	53	48	50	53	43	59
	OUTLET	32	51	57	59	58	56	54	47	64
5	INLET	32	45	49	51	47	49	45	33	56
	OUTLET	33	49	54	56	56	55	47	38	62
6	INLET	29	43	48	50	48	47	42	36	55
	OUTLET	30	47	52	56	56	53	47	40	61

PERFORMANCE CURVES

- q_v : Airflow in m^3/h .
- p_{st} : Static pressure in Pa.
- P: Input power in W.
- SFP: Specific Fan Power in $W/m^3/s$ (blue curves).
- Dry air at $20^\circ C$ and 760 mmHg.
- Performance data in accordance with ISO 5801 and AMCA 210-99 Standards.

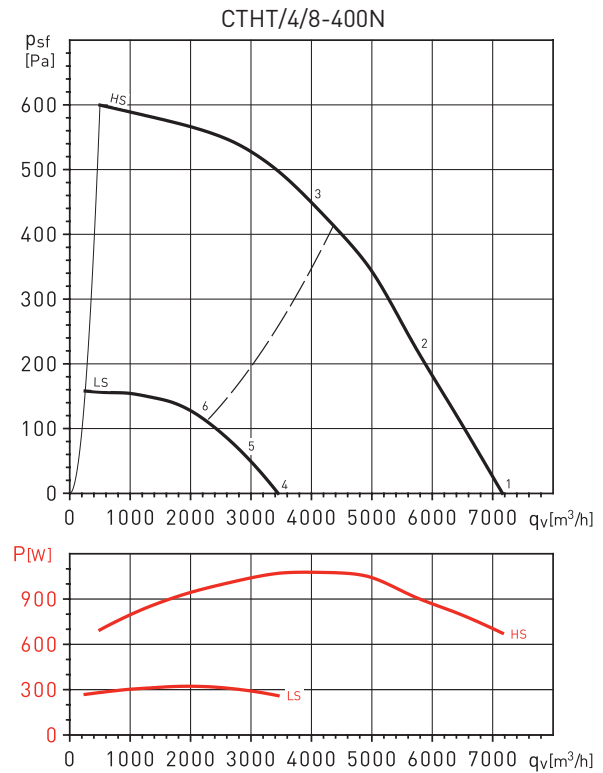
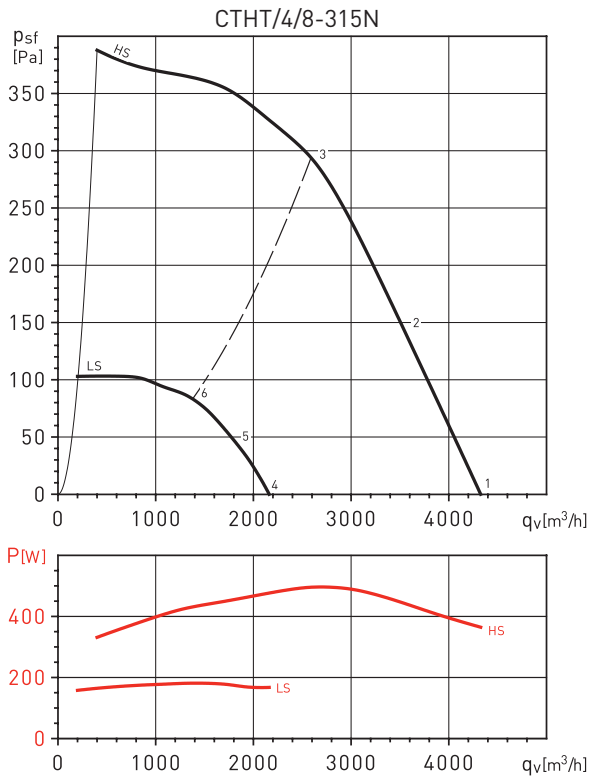

Sound power level spectrums in dB(A)

Working point		63	125	250	500	1000	2000	4000	8000	LwA
1	INLET	50	65	71	71	70	69	70	73	79
	OUTLET	52	69	76	78	77	74	74	72	84
2	INLET	50	63	71	70	68	67	67	69	77
	OUTLET	51	69	75	77	75	72	70	69	82
3	INLET	49	59	69	67	66	65	65	60	74
	OUTLET	51	67	71	75	72	69	68	63	79
4	INLET	36	51	57	57	56	55	56	59	65
	OUTLET	38	55	62	64	62	60	60	58	69
5	INLET	36	50	57	56	54	53	53	55	63
	OUTLET	37	56	61	63	61	58	57	55	68
6	INLET	36	45	55	53	52	51	52	47	60
	OUTLET	37	53	58	62	58	56	55	50	66

Sound power level spectrums in dB(A)

Working point		63	125	250	500	1000	2000	4000	8000	LwA
1	INLET	44	65	75	72	84	76	67	75	86
	OUTLET	47	74	76	86	89	85	73	78	93
2	INLET	41	63	75	71	79	69	65	65	81
	OUTLET	41	71	74	86	87	75	71	69	90
3	INLET	45	62	77	68	67	69	68	63	79
	OUTLET	43	70	72	83	78	72	72	68	85
4	INLET	30	51	61	58	70	62	53	61	72
	OUTLET	33	60	62	72	75	71	59	64	78
5	INLET	27	49	61	57	65	55	51	51	68
	OUTLET	27	57	60	72	73	61	57	55	76
6	INLET	31	48	63	54	53	55	54	49	65
	OUTLET	29	56	58	69	64	58	58	54	71

CENTRIFUGAL ROOF MOUNTED FANS MAX-TEMP CTVB-N/CTVT-N Series - VERTICAL DISCHARGE



PERFORMANCE CURVES

- q_v : Airflow in m^3/h .
- p_{st} : Static pressure in Pa.
- P: Input power in W.
- SFP: Specific Fan Power in $W/m^3/s$ (blue curves).
- Dry air at 20°C and 760 mmHg.
- Performance data in accordance with ISO 5801 and AMCA 210-99 Standards.

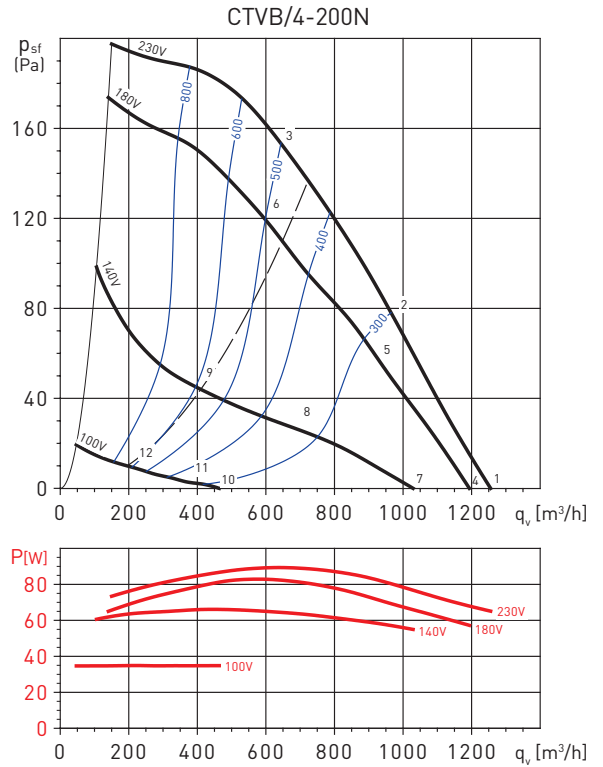
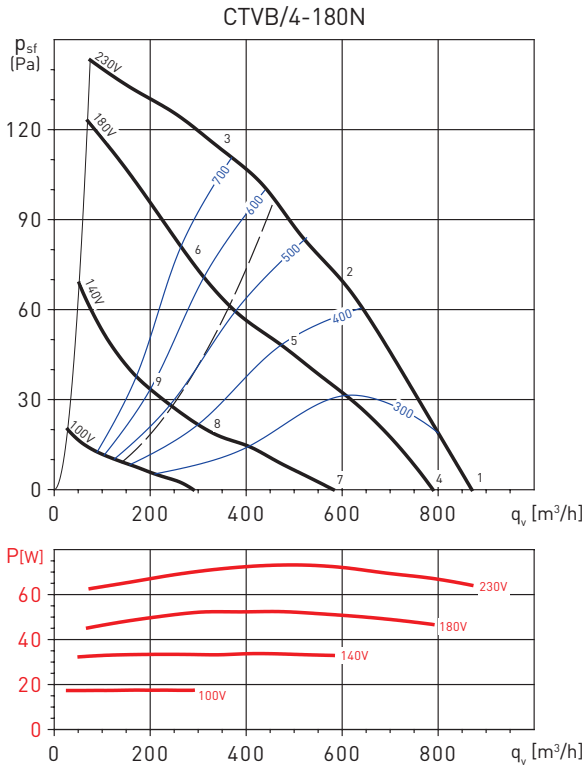

Sound power level spectrums in dB(A)

Working point		63	125	250	500	1000	2000	4000	8000	LwA
1	INLET	33	47	54	61	56	55	60	45	65
	OUTLET	35	48	56	65	62	61	62	47	69
2	INLET	34	47	53	60	55	54	53	44	63
	OUTLET	34	45	55	62	61	60	54	46	66
3	INLET	42	47	53	60	55	54	51	44	63
	OUTLET	43	48	55	63	62	61	55	47	67
4	INLET	31	45	52	59	54	52	58	43	63
	OUTLET	33	46	54	63	60	59	60	45	67
5	INLET	29	42	49	55	51	49	48	40	58
	OUTLET	30	40	50	57	56	55	50	41	61
6	INLET	38	43	48	56	51	50	47	40	59
	OUTLET	39	43	51	59	57	57	51	42	63
7	INLET	24	38	45	52	47	46	51	37	56
	OUTLET	26	39	48	56	53	53	53	38	60
8	INLET	20	34	40	46	42	40	39	31	49
	OUTLET	21	31	41	48	47	46	41	32	53
9	INLET	30	34	40	47	43	41	39	32	50
	OUTLET	30	35	42	50	49	48	42	34	54

Sound power level spectrums in dB(A)

Working point		63	125	250	500	1000	2000	4000	8000	LwA
1	INLET	35	50	59	60	59	58	63	46	67
	OUTLET	34	54	58	63	63	63	63	49	69
2	INLET	38	52	59	60	58	57	55	45	65
	OUTLET	36	53	57	63	63	62	57	49	68
3	INLET	41	52	59	60	59	57	55	46	66
	OUTLET	41	53	57	64	63	62	57	50	69
4	INLET	34	49	58	59	58	57	62	45	66
	OUTLET	33	53	57	63	62	62	62	48	69
5	INLET	36	50	57	58	56	55	53	43	63
	OUTLET	34	51	55	61	60	60	55	47	66
6	INLET	39	50	57	58	57	55	53	44	64
	OUTLET	39	51	55	62	61	60	55	48	67
7	INLET	31	46	55	56	55	54	59	41	63
	OUTLET	30	50	54	59	59	59	59	45	65
8	INLET	27	40	48	48	46	45	43	34	54
	OUTLET	25	41	45	51	51	50	45	37	56
9	INLET	29	40	47	48	47	45	43	34	54
	OUTLET	29	41	46	52	51	50	45	38	57
10	INLET	13	28	37	38	37	36	41	24	45
	OUTLET	12	32	36	42	41	41	41	27	48
11	INLET	11	24	31	32	30	29	27	17	38
	OUTLET	8	25	29	35	35	34	29	21	40
12	INLET	13	24	31	32	31	29	27	18	38
	OUTLET	13	25	30	36	35	34	29	22	41

CENTRIFUGAL ROOF MOUNTED FANS MAX-TEMP CTVB-N/CTVT-N Series - VERTICAL DISCHARGE



PERFORMANCE CURVES

- q_v : Airflow in m^3/h .
- p_{sf} : Static pressure in Pa.
- P: Input power in W.
- SFP: Specific Fan Power in $W/m^3/s$ (blue curves).
- Dry air at $20^\circ C$ and 760 mmHg.
- Performance data in accordance with ISO 5801 and AMCA 210-99 Standards.

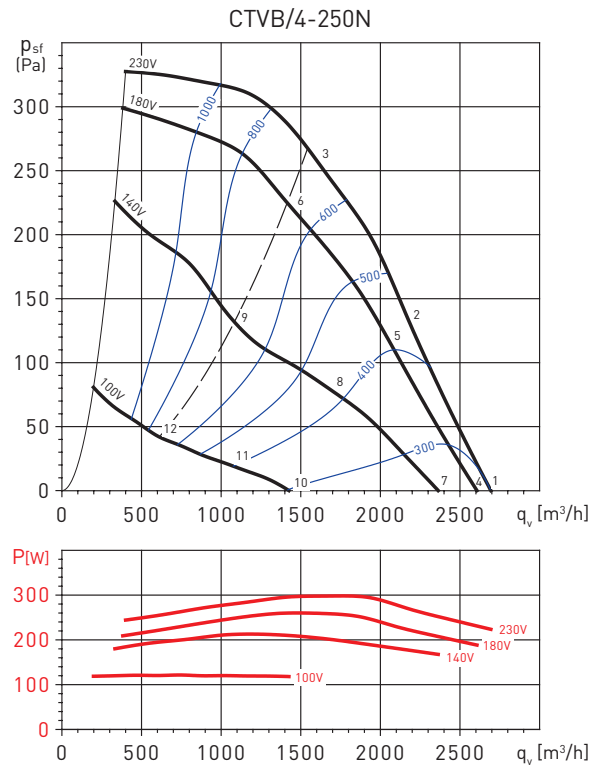
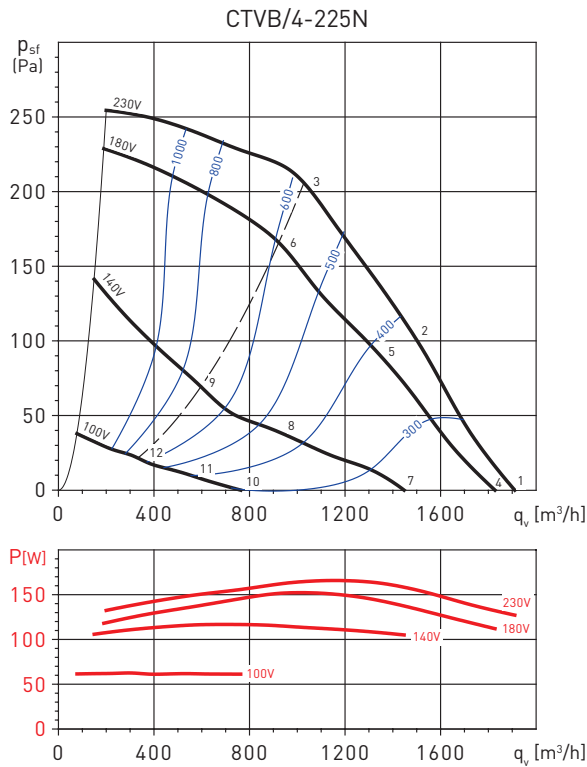

Sound power level spectrums in dB(A)

Working point		63	125	250	500	1000	2000	4000	8000	LwA
1	INLET	43	60	66	69	63	62	65	51	73
	OUTLET	47	62	65	72	70	67	65	53	76
2	INLET	43	57	64	68	61	59	58	46	71
	OUTLET	43	59	63	71	69	65	59	49	74
3	INLET	41	57	62	65	58	57	53	46	68
	OUTLET	42	58	61	68	65	62	55	48	71
4	INLET	42	59	65	68	62	61	64	50	72
	OUTLET	46	61	64	71	69	66	64	52	75
5	INLET	41	55	62	66	59	57	56	44	69
	OUTLET	41	57	61	69	67	63	57	47	72
6	INLET	39	55	60	63	56	55	51	44	66
	OUTLET	40	56	59	66	63	60	53	46	69
7	INLET	37	54	60	63	57	56	59	45	67
	OUTLET	41	56	59	66	64	61	59	47	70
8	INLET	32	46	53	57	50	48	47	35	60
	OUTLET	32	48	52	60	58	54	48	38	64
9	INLET	29	45	50	53	46	45	41	34	57
	OUTLET	30	46	49	56	53	50	43	36	60
10	INLET	23	40	46	49	43	42	45	31	53
	OUTLET	27	42	45	52	50	47	45	33	56
11	INLET	19	33	40	44	37	35	34	22	47
	OUTLET	19	35	39	47	45	41	35	25	51
12	INLET	16	32	37	40	33	32	28	21	44
	OUTLET	17	33	36	43	40	37	30	23	47

Sound power level spectrums in dB(A)

Working point		63	125	250	500	1000	2000	4000	8000	LwA
1	INLET	46	62	67	69	63	66	66	59	74
	OUTLET	47	65	70	70	70	70	67	58	77
2	INLET	44	59	65	67	62	66	58	54	72
	OUTLET	45	62	67	68	69	69	59	54	75
3	INLET	43	57	63	66	63	62	56	52	71
	OUTLET	45	61	66	67	69	66	60	53	74
4	INLET	46	62	67	69	63	66	66	59	74
	OUTLET	47	65	70	70	70	70	67	58	76
5	INLET	43	58	64	66	61	65	57	53	71
	OUTLET	44	61	66	67	68	68	58	53	74
6	INLET	42	56	62	65	62	61	55	51	69
	OUTLET	44	60	65	66	68	65	59	52	72
7	INLET	43	59	64	66	60	63	63	56	71
	OUTLET	44	62	67	67	67	67	64	55	74
8	INLET	39	54	60	62	57	61	53	49	67
	OUTLET	40	57	62	63	64	64	54	49	70
9	INLET	36	50	56	59	56	55	49	45	63
	OUTLET	38	54	59	60	62	59	53	46	67
10	INLET	32	48	53	55	49	52	52	45	60
	OUTLET	33	51	56	56	56	56	53	44	63
11	INLET	26	41	47	49	44	48	40	36	54
	OUTLET	27	44	49	50	51	51	41	36	57
12	INLET	23	37	43	46	43	42	36	32	51
	OUTLET	25	41	46	47	49	46	40	33	54

CENTRIFUGAL ROOF MOUNTED FANS MAX-TEMP CTVB-N/CTVT-N Series - VERTICAL DISCHARGE



PERFORMANCE CURVES

- q_v : Airflow in m^3/h .
- p_{sf} : Static pressure in Pa.
- P: Input power in W.
- SFP: Specific Fan Power in $W/m^3/s$ (blue curves).
- Dry air at 20°C and 760 mmHg.
- Performance data in accordance with ISO 5801 and AMCA 210-99 Standards.

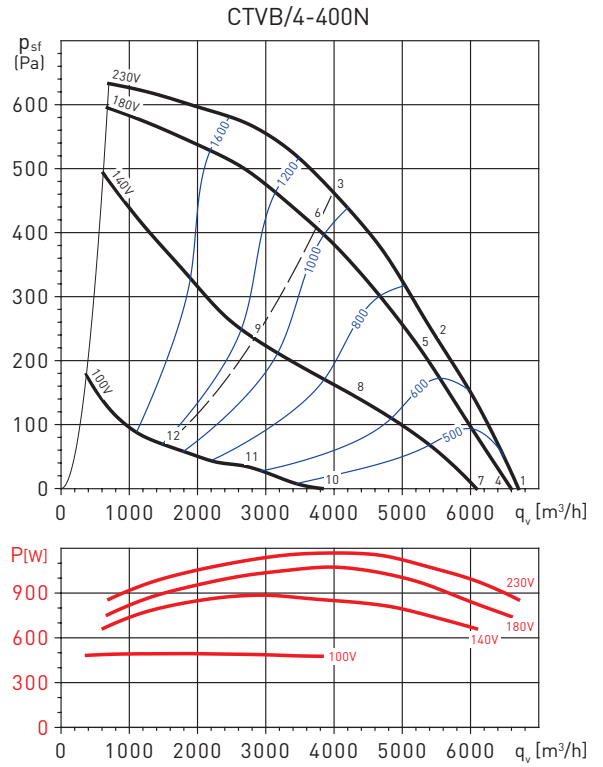
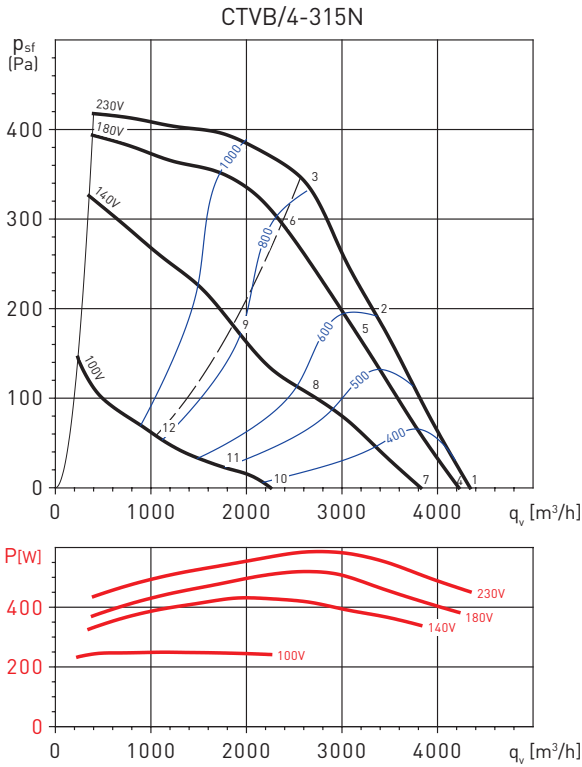

Sound power level spectrums in dB(A)

Working point		63	125	250	500	1000	2000	4000	8000	LwA
1	INLET	51	66	73	73	70	69	69	72	79
	OUTLET	52	70	76	76	76	73	69	71	82
2	INLET	49	64	70	70	68	67	63	64	76
	OUTLET	50	66	73	74	74	70	64	64	80
3	INLET	46	61	66	65	66	65	62	61	73
	OUTLET	46	63	68	69	71	68	63	61	76
4	INLET	50	66	72	72	69	69	68	71	79
	OUTLET	51	69	75	75	75	72	68	70	82
5	INLET	48	62	69	69	67	65	62	63	75
	OUTLET	48	65	72	73	73	69	63	63	78
6	INLET	45	59	64	64	65	64	61	59	71
	OUTLET	45	62	67	68	69	67	62	60	75
7	INLET	48	63	70	70	67	67	66	69	76
	OUTLET	49	67	73	73	73	70	66	68	79
8	INLET	43	58	65	65	62	61	57	58	70
	OUTLET	44	60	67	68	68	65	58	58	74
9	INLET	40	54	59	59	59	58	56	54	66
	OUTLET	39	56	62	63	64	61	57	54	69
10	INLET	37	52	59	59	56	55	55	58	65
	OUTLET	38	56	62	62	62	59	55	57	68
11	INLET	30	45	52	52	50	48	44	46	58
	OUTLET	31	48	55	55	56	52	45	46	61
12	INLET	27	42	47	46	47	46	44	42	54
	OUTLET	27	44	50	50	52	49	44	42	57

Sound power level spectrums in dB(A)

Working point		63	125	250	500	1000	2000	4000	8000	LwA
1	INLET	49	65	73	75	85	76	70	77	87
	OUTLET	59	73	75	78	88	81	71	76	90
2	INLET	47	64	72	75	80	71	68	70	83
	OUTLET	51	72	74	77	85	74	70	69	87
3	INLET	44	61	71	71	70	70	69	66	78
	OUTLET	46	69	71	73	75	72	69	66	80
4	INLET	48	64	72	74	84	75	69	76	86
	OUTLET	58	72	74	77	87	80	70	75	89
5	INLET	46	63	71	74	79	70	67	69	81
	OUTLET	50	71	73	76	84	73	69	68	85
6	INLET	43	60	70	70	69	69	68	65	76
	OUTLET	45	68	70	72	74	71	68	65	79
7	INLET	47	63	71	73	83	74	68	75	85
	OUTLET	57	71	73	76	86	79	69	74	87
8	INLET	42	59	67	70	75	66	63	65	77
	OUTLET	46	67	69	72	80	69	65	64	81
9	INLET	37	54	64	64	63	63	62	59	70
	OUTLET	39	62	64	66	68	65	62	59	73
10	INLET	38	54	62	64	74	65	59	66	75
	OUTLET	48	62	64	67	77	70	60	65	78
11	INLET	29	46	54	57	62	53	50	52	64
	OUTLET	33	54	56	59	67	56	52	51	68
12	INLET	23	40	50	50	49	49	48	45	57
	OUTLET	25	48	50	52	54	51	48	45	59

PERFORMANCE CURVES

- q_v : Airflow in m^3/h .
- p_{sf} : Static pressure in Pa.
- P: Input power in W.
- SFP: Specific Fan Power in $W/m^3/s$ (blue curves).
- Dry air at 20°C and 760 mmHg.
- Performance data in accordance with ISO 5801 and AMCA 210-99 Standards.

CTVB/6-200N

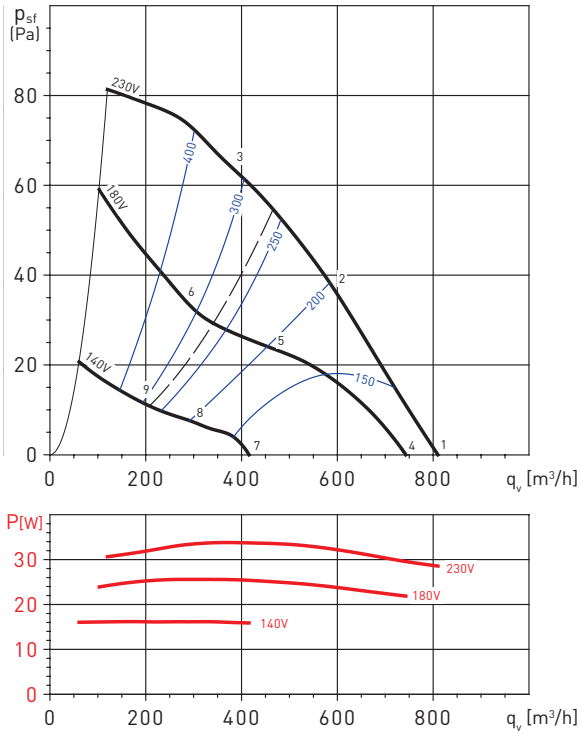

CTVB/6-225N

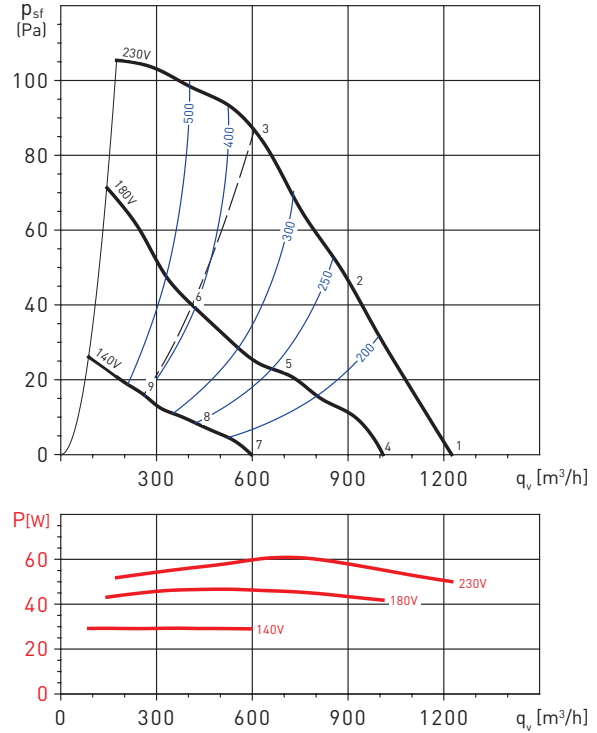

Sound power level spectrums in dB(A)

Working point		63	125	250	500	1000	2000	4000	8000	LwA
1	INLET	33	42	50	51	53	58	41	31	60
	OUTLET	31	44	48	54	58	60	43	40	63
2	INLET	33	41	49	50	53	50	41	36	57
	OUTLET	32	43	48	53	59	53	42	35	61
3	INLET	34	40	48	49	52	46	41	32	56
	OUTLET	34	42	47	52	58	51	43	35	60
4	INLET	31	40	48	49	52	56	39	30	59
	OUTLET	30	42	46	52	57	58	42	39	61
5	INLET	27	35	43	44	48	44	35	31	51
	OUTLET	26	37	42	47	53	48	36	29	56
6	INLET	28	33	42	43	46	40	35	26	50
	OUTLET	27	36	41	46	52	45	37	29	54
7	INLET	19	28	37	38	40	45	28	18	47
	OUTLET	18	31	35	41	45	47	30	27	50
8	INLET	16	24	32	33	37	33	24	19	40
	OUTLET	15	26	31	36	42	36	25	18	44
9	INLET	16	22	31	32	35	29	24	15	39
	OUTLET	16	25	30	35	41	34	25	18	43

Sound power level spectrums in dB(A)

Working point		63	125	250	500	1000	2000	4000	8000	LwA
1	INLET	39	46	52	53	51	57	54	33	61
	OUTLET	39	49	52	56	57	58	53	35	63
2	INLET	40	44	50	51	48	51	46	30	57
	OUTLET	41	46	48	54	55	53	46	33	60
3	INLET	41	42	48	49	46	45	44	31	54
	OUTLET	41	43	45	51	53	49	45	33	57
4	INLET	35	43	49	50	47	53	51	29	58
	OUTLET	36	45	48	53	54	54	50	32	60
5	INLET	33	37	43	44	41	44	39	23	50
	OUTLET	34	39	41	47	48	46	39	26	53
6	INLET	33	33	40	41	38	37	36	23	46
	OUTLET	33	35	37	43	44	41	37	25	49
7	INLET	24	31	38	38	36	42	39	18	46
	OUTLET	25	34	37	42	42	43	38	20	48
8	INLET	22	27	33	33	31	34	28	13	40
	OUTLET	24	29	31	37	38	35	28	16	42
9	INLET	23	23	30	31	28	27	26	13	36
	OUTLET	23	25	27	33	34	31	27	15	39
10	INLET	12	19	25	26	24	30	27	6	34
	OUTLET	12	22	25	29	30	31	26	8	36
11	INLET	12	16	21	24	23	24	19	4	30
	OUTLET	12	17	21	25	25	24	19	4	31
12	INLET	12	16	21	24	23	24	19	4	30
	OUTLET	12	16	21	24	23	24	19	4	30

CENTRIFUGAL ROOF MOUNTED FANS MAX-TEMP CTVB-N/CTVT-N Series - VERTICAL DISCHARGE



PERFORMANCE CURVES

- q_v : Airflow in m^3/h .
- p_{sf} : Static pressure in Pa.
- P: Input power in W.
- SFP: Specific Fan Power in $W/m^3/s$ (blue curves).
- Dry air at 20°C and 760 mmHg.
- Performance data in accordance with ISO 5801 and AMCA 210-99 Standards.

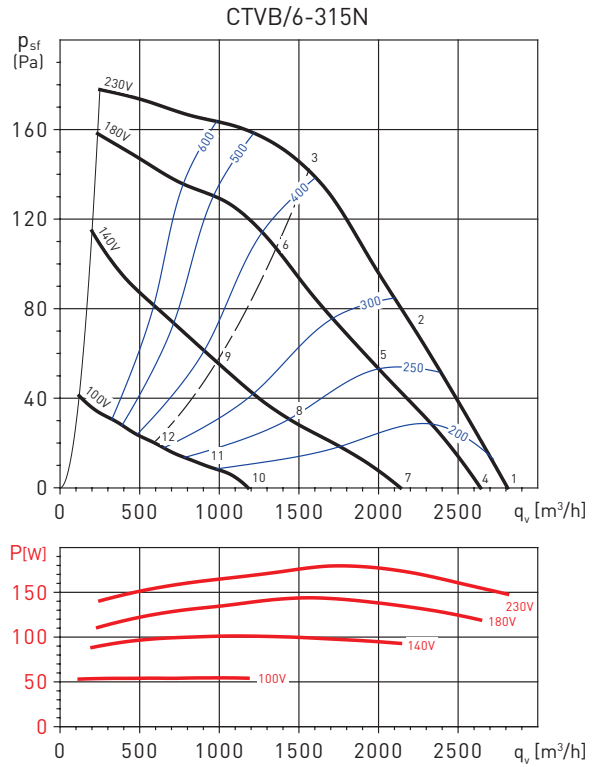
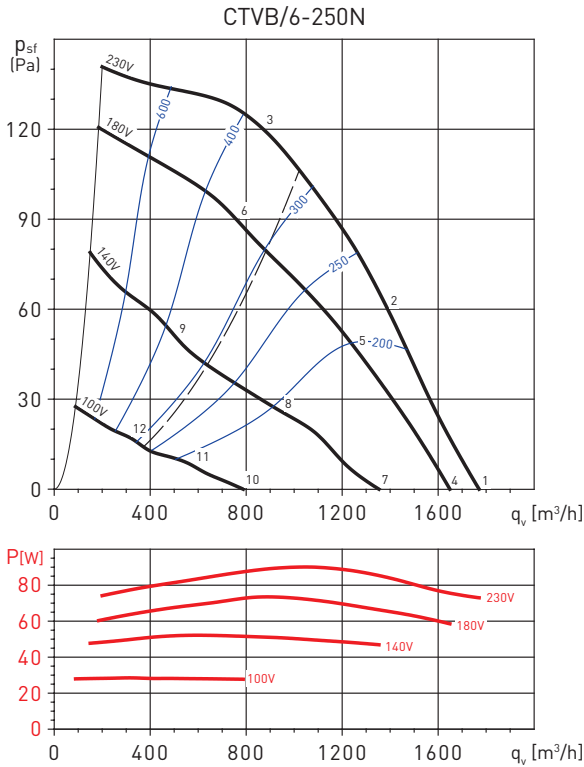

Sound power level spectrums in dB(A)

Working point		63	125	250	500	1000	2000	4000	8000	LwA
1	INLET	43	50	56	58	54	55	59	35	64
	OUTLET	45	54	59	59	62	59	59	38	67
2	INLET	44	48	54	56	53	51	53	34	61
	OUTLET	47	52	57	57	60	54	53	36	64
3	INLET	44	47	52	55	53	51	45	37	59
	OUTLET	45	49	54	56	58	54	47	38	62
4	INLET	41	48	54	56	52	53	57	33	62
	OUTLET	43	52	57	57	60	57	57	36	65
5	INLET	41	45	51	53	50	48	50	31	58
	OUTLET	44	49	54	54	57	51	50	33	61
6	INLET	40	43	48	51	49	47	41	33	56
	OUTLET	41	45	50	52	54	50	43	34	59
7	INLET	37	44	50	52	48	49	53	29	58
	OUTLET	39	48	53	53	56	53	53	32	61
8	INLET	35	39	45	47	44	42	44	25	52
	OUTLET	38	43	48	48	51	45	44	27	55
9	INLET	34	37	42	45	43	41	35	27	49
	OUTLET	35	39	44	46	48	44	37	28	52
10	INLET	25	32	38	40	36	37	41	17	46
	OUTLET	27	36	41	41	44	41	41	20	49
11	INLET	23	27	33	35	32	30	32	13	40
	OUTLET	26	31	36	36	39	33	32	15	44
12	INLET	22	25	30	33	31	29	23	15	38
	OUTLET	23	27	32	34	36	32	25	16	41

Sound power level spectrums in dB(A)

Working point		63	125	250	500	1000	2000	4000	8000	LwA
1	INLET	46	55	62	61	59	61	64	44	69
	OUTLET	48	58	64	64	64	64	63	45	71
2	INLET	47	52	59	58	58	57	59	40	66
	OUTLET	48	54	61	62	62	59	59	40	68
3	INLET	46	48	53	55	56	56	57	40	63
	OUTLET	47	50	56	58	60	57	57	41	65
4	INLET	45	53	60	59	58	60	63	42	68
	OUTLET	46	56	62	63	63	62	62	43	70
5	INLET	44	50	56	56	55	54	57	37	63
	OUTLET	45	52	58	59	60	56	56	38	65
6	INLET	44	45	50	52	53	53	54	37	60
	OUTLET	44	47	53	55	57	54	54	38	62
7	INLET	40	49	56	55	53	55	58	38	63
	OUTLET	42	52	58	58	58	58	57	39	65
8	INLET	37	43	49	49	48	48	50	30	56
	OUTLET	39	45	52	53	53	49	49	31	59
9	INLET	37	39	43	45	46	46	48	30	53
	OUTLET	37	40	46	48	50	47	47	31	55
10	INLET	28	37	44	43	42	43	47	26	51
	OUTLET	30	40	46	46	47	46	45	27	53
11	INLET	27	32	39	38	38	37	39	20	46
	OUTLET	28	35	41	42	43	39	39	21	48
12	INLET	26	28	32	34	35	35	37	19	42
	OUTLET	26	29	35	37	39	36	36	20	44

PERFORMANCE CURVES

- q_v : Airflow in m^3/h .
- p_{sf} : Static pressure in Pa.
- P: Input power in W.
- SFP: Specific Fan Power in $W/m^3/s$ (blue curves).
- Dry air at $20^\circ C$ and 760 mmHg.
- Performance data in accordance with ISO 5801 and AMCA 210-99 Standards.

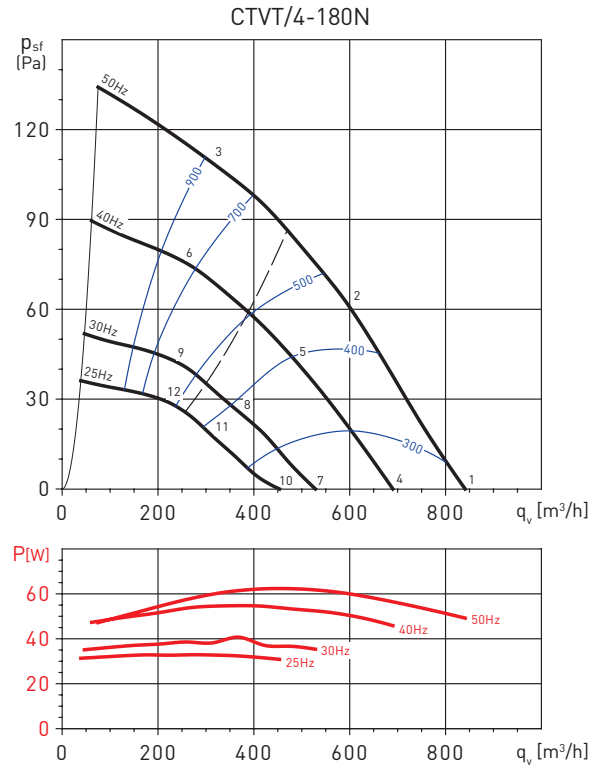
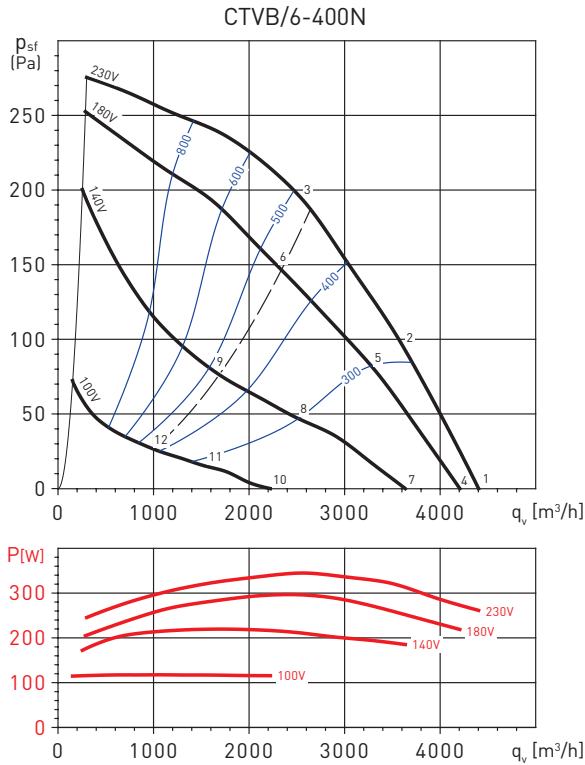

Sound power level spectrums in dB(A)

Working point		63	125	250	500	1000	2000	4000	8000	LwA
1	INLET	42	53	63	70	71	64	71	55	76
	OUTLET	46	58	65	72	77	65	70	54	79
2	INLET	45	53	61	68	66	63	67	53	73
	OUTLET	47	56	63	71	71	64	66	53	75
3	INLET	44	52	58	60	61	64	64	53	69
	OUTLET	45	53	60	63	65	65	63	53	71
4	INLET	41	52	62	69	70	63	70	54	75
	OUTLET	45	57	64	71	76	64	69	53	78
5	INLET	43	51	59	66	64	61	65	51	71
	OUTLET	45	54	61	69	69	62	64	51	73
6	INLET	41	49	55	57	58	61	61	50	67
	OUTLET	42	50	57	60	62	62	60	50	68
7	INLET	38	49	59	66	67	60	67	51	72
	OUTLET	42	54	61	68	73	61	66	50	75
8	INLET	38	46	54	61	59	56	60	46	65
	OUTLET	40	49	56	64	64	57	59	46	68
9	INLET	34	42	48	50	51	54	54	43	59
	OUTLET	35	43	50	53	55	55	53	43	61
10	INLET	27	38	48	55	56	49	56	40	61
	OUTLET	31	43	50	57	62	50	55	39	64
11	INLET	26	34	42	49	47	44	48	34	54
	OUTLET	28	37	44	52	52	45	47	34	56
12	INLET	23	31	37	39	40	43	43	32	48
	OUTLET	24	32	39	42	44	44	42	32	50

Sound power level spectrums in dB(A)

Working point		63	125	250	500	1000	2000	4000	8000	LwA
1	INLET	32	46	53	60	55	54	59	45	64
	OUTLET	34	47	56	64	61	61	61	46	68
2	INLET	33	46	53	59	54	53	52	43	62
	OUTLET	34	44	54	61	60	59	53	45	65
3	INLET	42	46	52	59	55	53	51	44	62
	OUTLET	42	47	54	62	61	60	54	46	66
4	INLET	28	42	49	55	50	49	54	40	60
	OUTLET	30	43	51	60	57	56	57	42	64
5	INLET	29	42	49	55	50	49	48	39	58
	OUTLET	29	40	50	57	56	55	49	41	61
6	INLET	38	42	48	55	50	49	47	40	58
	OUTLET	38	43	50	58	57	56	50	42	62
7	INLET	22	36	43	50	45	43	49	34	54
	OUTLET	24	37	45	54	51	50	51	36	58
8	INLET	23	37	43	49	45	43	42	34	52
	OUTLET	24	34	44	51	50	49	44	35	56
9	INLET	32	36	42	49	45	43	41	34	52
	OUTLET	32	37	45	52	51	50	44	36	57
10	INLET	18	32	39	46	41	40	45	31	50
	OUTLET	20	33	42	50	47	47	47	32	54
11	INLET	20	33	39	45	41	39	39	30	49
	OUTLET	20	31	41	47	46	45	40	32	52
12	INLET	28	33	38	46	41	40	37	30	49
	OUTLET	29	33	41	49	47	47	41	32	53

CENTRIFUGAL ROOF MOUNTED FANS MAX-TEMP CTVB-N/CTVT-N Series - VERTICAL DISCHARGE



PERFORMANCE CURVES

- q_v : Airflow in m^3/h .
- p_{sf} : Static pressure in Pa.
- P: Input power in W.
- SFP: Specific Fan Power in $W/m^3/s$ (blue curves).
- Dry air at 20°C and 760 mmHg.
- Performance data in accordance with ISO 5801 and AMCA 210-99 Standards.

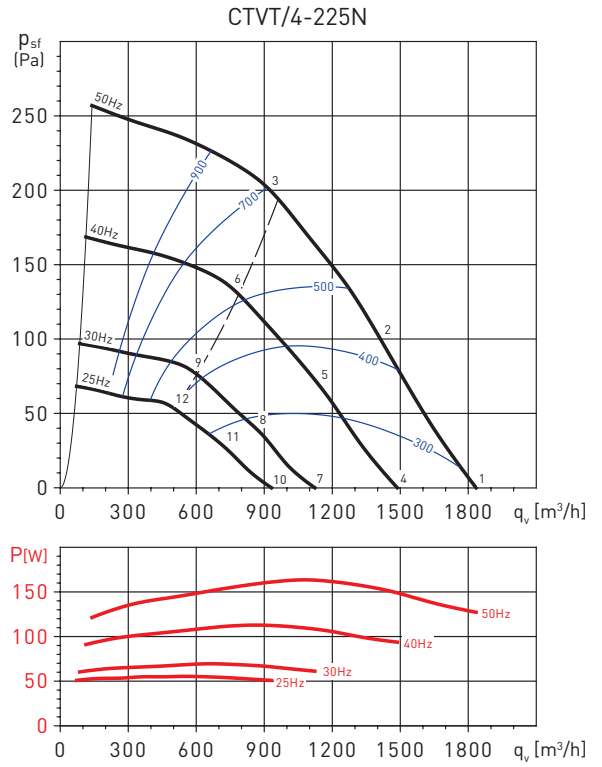
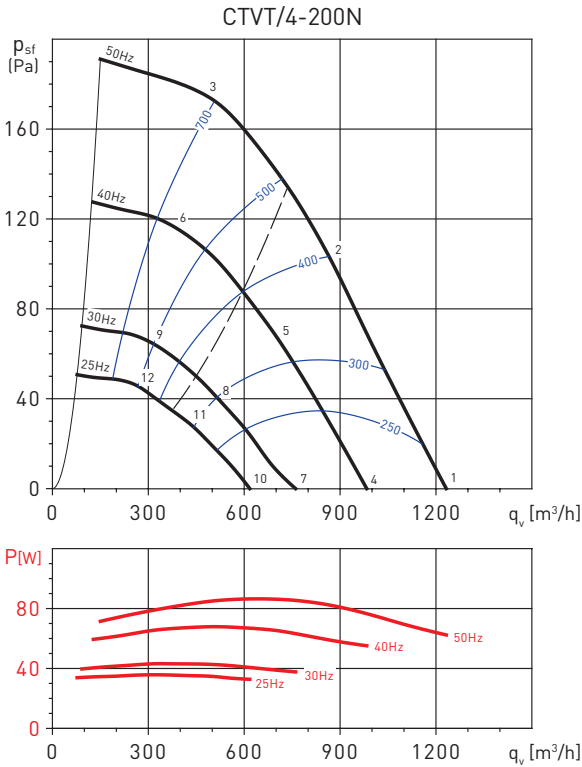

Sound power level spectrums in dB(A)

Working point		63	125	250	500	1000	2000	4000	8000	LwA
1	INLET	35	49	58	60	59	58	62	45	67
	OUTLET	34	54	58	63	63	63	62	49	69
2	INLET	38	51	59	60	58	57	55	45	65
	OUTLET	36	53	57	63	62	62	57	48	68
3	INLET	40	51	59	60	59	57	55	46	65
	OUTLET	40	53	57	63	63	62	57	49	68
4	INLET	30	45	54	55	54	53	58	41	62
	OUTLET	29	49	53	59	58	58	58	44	65
5	INLET	34	47	55	55	53	52	50	41	61
	OUTLET	32	48	52	58	58	57	52	44	63
6	INLET	36	47	55	55	54	52	51	41	61
	OUTLET	36	48	53	59	58	57	52	45	64
7	INLET	24	39	48	49	48	47	52	35	56
	OUTLET	23	43	47	53	52	52	52	38	59
8	INLET	28	41	49	49	47	46	45	35	55
	OUTLET	26	43	47	52	52	51	46	38	58
9	INLET	30	41	49	49	49	47	45	35	55
	OUTLET	30	42	47	53	52	51	46	39	58
10	INLET	20	35	44	45	44	43	48	31	52
	OUTLET	19	39	43	49	48	48	48	34	55
11	INLET	24	37	45	45	44	43	41	31	51
	OUTLET	22	39	43	49	48	48	43	34	54
12	INLET	26	37	45	46	45	43	41	32	51
	OUTLET	26	39	43	49	49	48	43	35	54

Sound power level spectrums in dB(A)

Working point		63	125	250	500	1000	2000	4000	8000	LwA
1	INLET	43	60	66	69	63	62	65	51	73
	OUTLET	47	62	65	72	70	67	65	53	76
2	INLET	43	57	64	68	61	59	58	46	71
	OUTLET	43	59	63	71	69	65	59	49	74
3	INLET	41	57	62	65	58	57	53	46	68
	OUTLET	42	58	61	68	65	62	55	48	71
4	INLET	38	55	61	64	58	57	60	46	68
	OUTLET	42	57	60	67	65	62	60	48	71
5	INLET	38	52	59	63	56	54	53	41	66
	OUTLET	38	54	58	66	64	60	54	44	70
6	INLET	36	52	57	60	53	52	48	41	64
	OUTLET	37	53	56	63	60	57	50	43	67
7	INLET	32	49	55	58	52	51	54	40	62
	OUTLET	36	51	54	61	59	56	54	42	65
8	INLET	32	46	53	57	50	48	47	35	60
	OUTLET	32	48	52	60	58	54	48	38	64
9	INLET	30	46	51	54	47	46	42	35	58
	OUTLET	31	47	50	57	54	51	44	37	61
10	INLET	28	45	51	54	48	47	50	36	58
	OUTLET	32	47	50	57	55	52	50	38	61
11	INLET	29	43	50	54	47	45	44	32	56
	OUTLET	29	45	49	57	55	51	45	35	60
12	INLET	27	43	48	51	44	43	39	32	54
	OUTLET	28	44	47	54	51	48	41	34	57

CENTRIFUGAL ROOF MOUNTED FANS MAX-TEMP CTVB-N/CTVT-N Series - VERTICAL DISCHARGE



PERFORMANCE CURVES

- q_v : Airflow in m^3/h .
- p_{sf} : Static pressure in Pa.
- P: Input power in W.
- SFP: Specific Fan Power in $W/m^3/s$ (blue curves).
- Dry air at $20^\circ C$ and 760 mmHg.
- Performance data in accordance with ISO 5801 and AMCA 210-99 Standards.

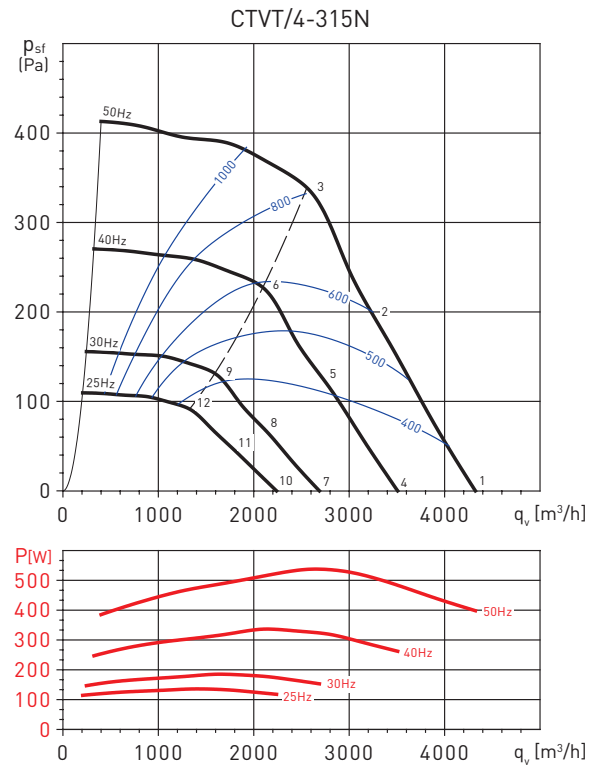
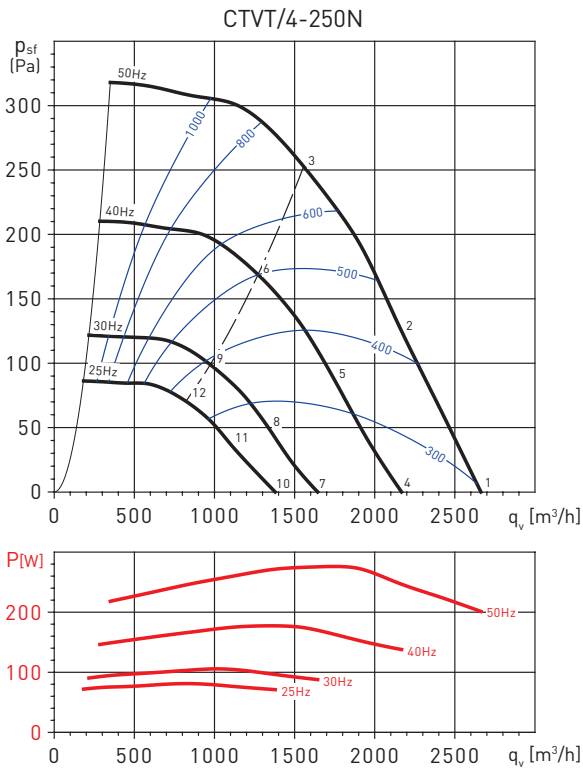

Sound power level spectrums in dB(A)

Working point		63	125	250	500	1000	2000	4000	8000	LwA
1	INLET	46	62	67	69	63	66	66	59	74
	OUTLET	47	65	70	70	70	70	67	58	77
2	INLET	44	59	65	67	62	66	58	54	72
	OUTLET	45	62	67	68	69	69	59	54	75
3	INLET	43	57	63	66	63	62	56	52	70
	OUTLET	45	61	66	67	69	66	60	53	74
4	INLET	41	57	62	64	58	61	61	54	69
	OUTLET	42	60	65	65	65	65	62	53	72
5	INLET	40	55	61	63	58	62	54	50	67
	OUTLET	41	58	63	64	65	65	55	50	70
6	INLET	39	53	59	62	59	58	52	48	66
	OUTLET	41	57	62	63	65	62	56	49	69
7	INLET	35	51	56	58	52	55	55	48	64
	OUTLET	36	54	59	59	59	59	56	47	66
8	INLET	34	49	55	57	52	56	48	44	62
	OUTLET	35	52	57	58	59	59	49	44	65
9	INLET	33	47	53	56	53	52	46	42	60
	OUTLET	35	51	56	57	59	56	50	43	64
10	INLET	32	48	53	55	49	52	52	45	60
	OUTLET	33	51	56	56	56	56	53	44	63
11	INLET	30	45	51	53	48	52	44	40	58
	OUTLET	31	48	53	54	55	55	45	40	61
12	INLET	29	43	49	52	49	48	42	38	56
	OUTLET	31	47	52	53	55	52	46	39	60

Sound power level spectrums in dB(A)

Working point		63	125	250	500	1000	2000	4000	8000	LwA
1	INLET	51	66	73	72	70	69	69	72	79
	OUTLET	52	70	76	76	76	73	69	71	82
2	INLET	49	63	70	70	68	66	63	64	76
	OUTLET	50	66	73	74	74	70	64	64	80
3	INLET	46	60	66	65	66	65	62	61	73
	OUTLET	46	63	68	69	71	68	63	61	76
4	INLET	46	62	68	68	65	65	64	67	75
	OUTLET	47	65	71	71	71	68	64	66	78
5	INLET	44	59	66	66	64	62	58	60	71
	OUTLET	45	62	69	69	70	66	59	60	75
6	INLET	42	56	61	61	62	61	58	56	68
	OUTLET	42	59	64	65	66	64	59	56	71
7	INLET	40	56	62	62	59	59	58	61	68
	OUTLET	41	59	65	65	65	62	58	60	72
8	INLET	39	53	60	60	58	56	52	54	66
	OUTLET	39	56	63	64	64	60	54	54	69
9	INLET	36	50	55	55	56	55	52	51	62
	OUTLET	36	53	58	59	60	58	53	51	66
10	INLET	36	52	58	58	55	55	54	57	65
	OUTLET	38	55	61	61	62	58	54	57	68
11	INLET	35	49	56	56	54	52	49	50	62
	OUTLET	35	52	59	60	60	56	50	50	65
12	INLET	32	46	52	51	52	51	48	47	59
	OUTLET	32	49	54	55	57	54	49	47	62

CENTRIFUGAL ROOF MOUNTED FANS MAX-TEMP CTVB-N/CTVT-N Series - VERTICAL DISCHARGE



PERFORMANCE CURVES

- q_v : Airflow in m^3/h .
- p_{sf} : Static pressure in Pa.
- P: Input power in W.
- SFP: Specific Fan Power in $W/m^3/s$ (blue curves).
- Dry air at 20°C and 760 mmHg.
- Performance data in accordance with ISO 5801 and AMCA 210-99 Standards.

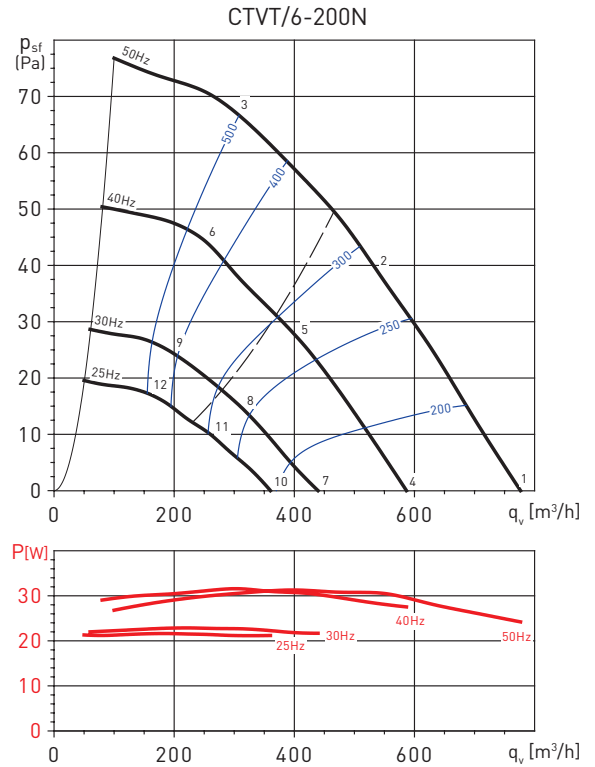
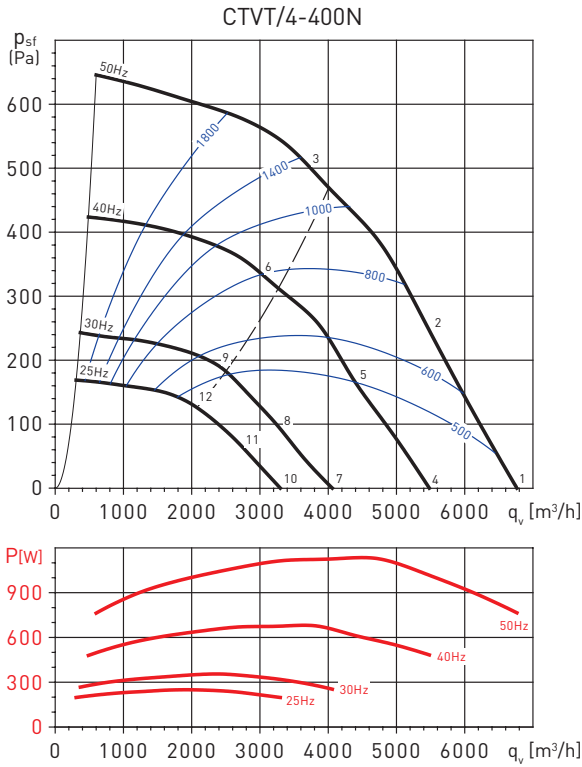

Sound power level spectrums in dB(A)

Working point		63	125	250	500	1000	2000	4000	8000	LwA
1	INLET	44	63	72	72	85	76	71	76	86
	OUTLET	59	72	75	77	88	82	75	76	90
2	INLET	43	61	73	71	80	71	67	68	82
	OUTLET	51	71	73	76	85	74	70	68	86
3	INLET	44	62	71	68	69	70	68	64	77
	OUTLET	48	68	71	73	74	72	70	65	80
4	INLET	39	58	67	67	80	71	66	71	82
	OUTLET	54	67	70	72	83	77	70	71	85
5	INLET	39	57	69	67	76	67	63	64	78
	OUTLET	47	67	69	72	81	70	66	64	82
6	INLET	40	58	67	64	65	66	64	60	72
	OUTLET	44	64	67	69	70	68	66	61	75
7	INLET	33	52	61	61	74	65	60	65	76
	OUTLET	48	61	64	66	77	71	64	65	79
8	INLET	33	51	63	61	70	61	57	58	72
	OUTLET	41	61	63	66	75	64	60	58	76
9	INLET	34	52	61	58	59	60	58	54	66
	OUTLET	38	58	61	63	64	62	60	55	69
10	INLET	29	48	57	57	70	61	56	61	72
	OUTLET	44	57	60	62	73	67	60	61	75
11	INLET	29	47	59	57	66	57	53	54	68
	OUTLET	37	57	59	62	71	60	56	54	72
12	INLET	30	48	57	54	55	56	54	50	63
	OUTLET	34	54	57	59	60	58	56	51	65

Sound power level spectrums in dB(A)

Working point		63	125	250	500	1000	2000	4000	8000	LwA
1	INLET	32	41	49	50	53	57	40	31	60
	OUTLET	31	43	47	53	58	59	43	40	62
2	INLET	32	41	48	49	53	49	40	36	57
	OUTLET	32	43	48	52	59	53	41	34	61
3	INLET	33	39	48	49	52	46	41	31	55
	OUTLET	33	42	47	52	57	51	42	35	60
4	INLET	28	37	45	46	48	53	36	26	55
	OUTLET	26	39	43	49	53	55	38	35	58
5	INLET	28	36	44	45	49	45	36	31	52
	OUTLET	27	38	43	48	54	48	37	30	56
6	INLET	29	35	43	44	47	41	36	27	51
	OUTLET	29	37	42	47	53	46	38	30	55
7	INLET	21	30	39	40	42	47	30	20	49
	OUTLET	20	33	37	43	47	49	32	29	52
8	INLET	22	30	38	39	42	39	30	25	46
	OUTLET	21	32	37	42	48	42	31	24	50
9	INLET	23	29	37	38	41	35	30	21	45
	OUTLET	23	31	36	41	47	40	32	24	49
10	INLET	17	26	34	35	38	42	25	16	45
	OUTLET	16	29	32	38	43	44	28	25	48
11	INLET	18	26	34	34	38	35	26	21	42
	OUTLET	17	28	33	38	44	38	27	20	46
12	INLET	19	25	33	34	37	31	26	17	41
	OUTLET	19	27	32	37	43	36	28	20	45

CENTRIFUGAL ROOF MOUNTED FANS MAX-TEMP CTVB-N/CTVT-N Series - VERTICAL DISCHARGE



PERFORMANCE CURVES

- q_v : Airflow in m^3/h .
- p_{sf} : Static pressure in Pa.
- P: Input power in W.
- SFP: Specific Fan Power in $W/m^3/s$ (blue curves).
- Dry air at $20^\circ C$ and 760 mmHg.
- Performance data in accordance with ISO 5801 and AMCA 210-99 Standards.

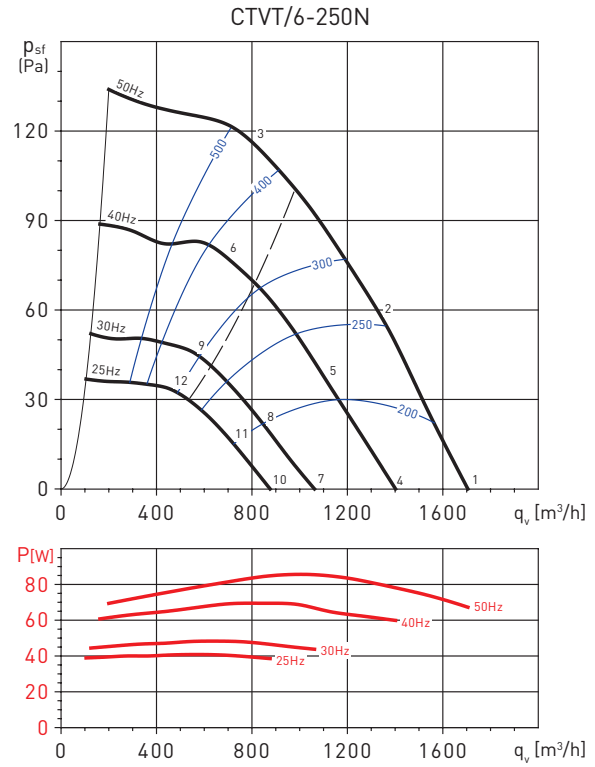
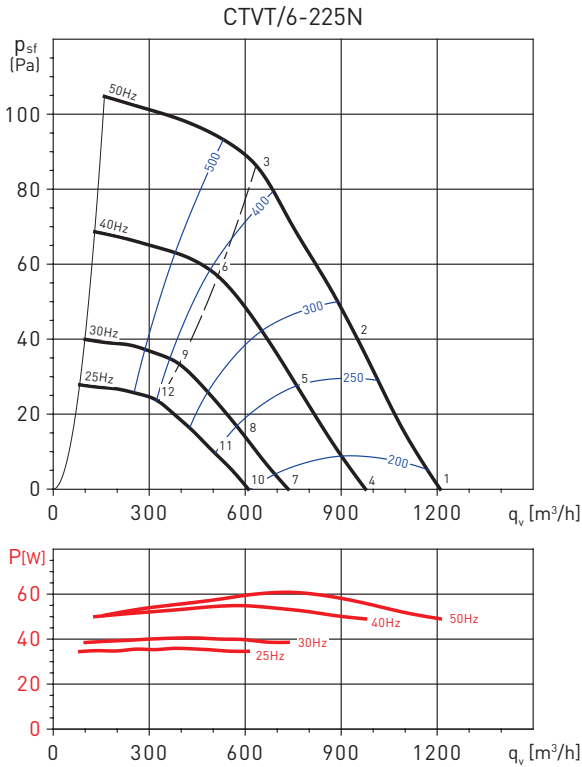

Sound power level spectrums in dB(A)

Working point		63	125	250	500	1000	2000	4000	8000	LwA
1	INLET	40	46	52	53	52	55	55	32	61
	OUTLET	40	48	51	56	58	57	55	34	63
2	INLET	40	44	49	51	52	50	48	30	58
	OUTLET	41	46	49	54	58	52	48	31	61
3	INLET	42	42	47	49	46	45	45	31	54
	OUTLET	43	44	46	53	53	49	45	32	58
4	INLET	35	41	47	48	47	50	50	27	56
	OUTLET	35	43	46	51	53	52	50	29	59
5	INLET	36	40	45	47	48	46	44	26	53
	OUTLET	37	42	45	50	54	48	44	27	57
6	INLET	38	38	43	45	42	41	41	27	50
	OUTLET	39	40	42	49	49	45	41	28	53
7	INLET	29	35	41	42	41	44	44	21	50
	OUTLET	29	37	40	45	47	46	44	23	53
8	INLET	30	34	39	41	42	40	38	20	47
	OUTLET	31	36	39	44	48	42	38	21	51
9	INLET	32	32	37	39	36	35	35	21	44
	OUTLET	33	34	36	43	43	39	35	22	48
10	INLET	26	32	38	39	38	41	41	18	46
	OUTLET	26	34	37	42	44	43	41	20	49
11	INLET	26	30	35	37	38	36	34	16	43
	OUTLET	27	32	35	40	44	38	34	17	47
12	INLET	28	28	33	35	32	31	31	17	40
	OUTLET	29	30	32	39	39	35	31	18	44

Sound power level spectrums in dB(A)

Working point		63	125	250	500	1000	2000	4000	8000	LwA
1	INLET	42	49	55	57	53	54	58	34	63
	OUTLET	44	53	58	58	61	58	58	37	66
2	INLET	43	47	53	55	52	50	52	33	60
	OUTLET	46	51	56	56	59	53	52	35	63
3	INLET	43	46	51	54	52	50	44	36	59
	OUTLET	44	48	53	55	57	53	46	37	61
4	INLET	38	45	51	53	49	50	54	30	59
	OUTLET	40	49	54	54	57	54	54	33	62
5	INLET	39	43	49	51	48	46	48	29	56
	OUTLET	42	47	52	52	55	49	48	31	59
6	INLET	39	42	47	50	48	46	40	32	54
	OUTLET	40	44	49	51	53	49	42	33	57
7	INLET	32	39	45	47	43	44	48	24	53
	OUTLET	34	43	48	48	51	48	48	27	56
8	INLET	33	37	43	45	42	40	42	23	50
	OUTLET	36	41	46	46	49	43	42	25	53
9	INLET	33	36	41	44	42	40	34	26	49
	OUTLET	34	38	43	45	47	43	36	27	51
10	INLET	28	35	41	43	39	40	44	20	49
	OUTLET	30	39	44	44	47	44	44	23	52
11	INLET	29	33	39	41	38	36	38	19	46
	OUTLET	32	37	42	42	45	39	38	21	50
12	INLET	29	32	37	40	38	36	30	22	45
	OUTLET	30	34	39	41	43	39	32	23	48

CENTRIFUGAL ROOF MOUNTED FANS MAX-TEMP CTVB-N/CTVT-N Series - VERTICAL DISCHARGE



PERFORMANCE CURVES

- q_v : Airflow in m^3/h .
- p_{sf} : Static pressure in Pa.
- P: Input power in W.
- SFP: Specific Fan Power in $W/m^3/s$ (blue curves).
- Dry air at 20°C and 760 mmHg.
- Performance data in accordance with ISO 5801 and AMCA 210-99 Standards.

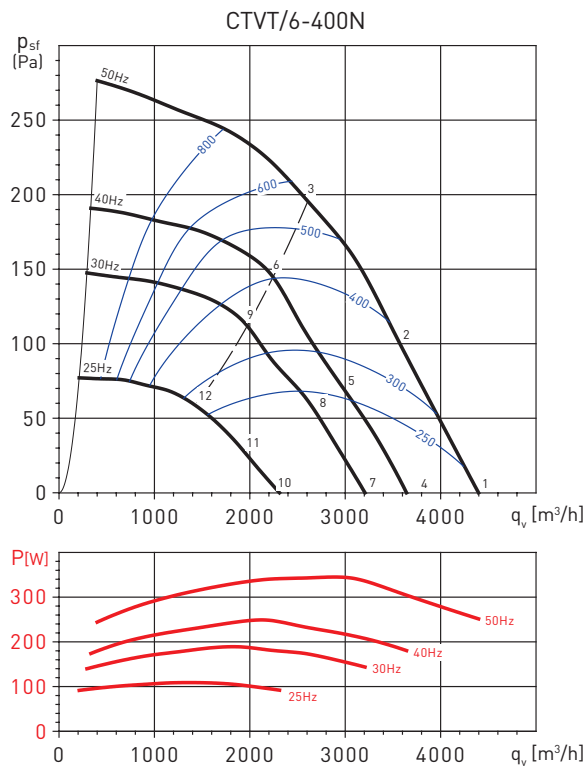
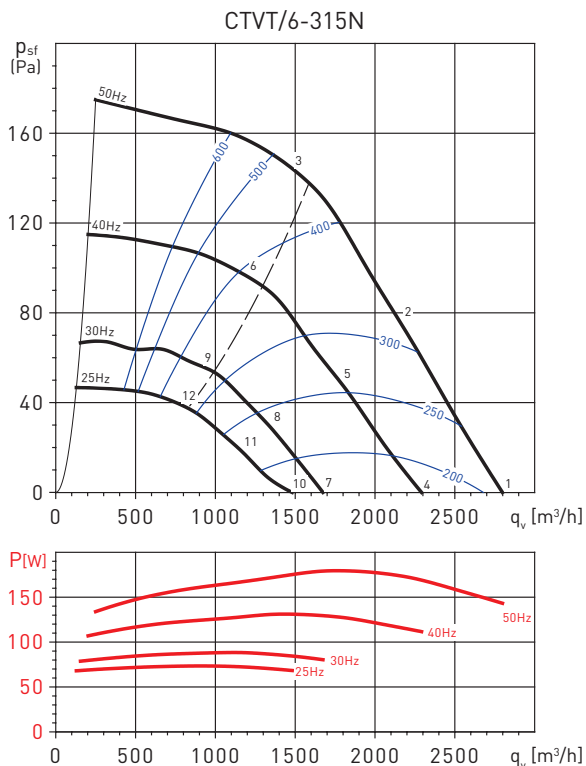

Sound power level spectrums in dB(A)

Working point		63	125	250	500	1000	2000	4000	8000	LwA
1	INLET	46	55	61	61	59	61	64	43	69
	OUTLET	47	58	63	64	64	64	63	44	71
2	INLET	47	52	59	58	58	57	59	40	66
	OUTLET	48	55	61	62	62	59	59	40	68
3	INLET	46	48	53	55	56	56	57	40	63
	OUTLET	47	50	56	58	60	57	57	41	65
4	INLET	42	50	57	56	55	57	60	39	64
	OUTLET	43	53	59	59	60	59	58	40	66
5	INLET	42	48	54	54	53	53	55	35	61
	OUTLET	44	50	56	58	58	54	54	36	64
6	INLET	42	44	49	50	51	52	53	35	58
	OUTLET	43	45	51	54	56	53	53	36	61
7	INLET	36	44	51	50	49	51	54	33	58
	OUTLET	37	47	53	54	54	53	52	34	61
8	INLET	37	42	49	48	48	47	49	30	56
	OUTLET	38	45	51	52	52	49	49	30	58
9	INLET	36	38	43	44	45	46	47	30	53
	OUTLET	37	40	45	48	50	47	47	30	55
10	INLET	32	41	47	46	45	47	50	29	55
	OUTLET	33	43	49	50	50	50	49	30	57
11	INLET	33	39	45	45	44	43	46	26	52
	OUTLET	34	41	47	48	49	45	45	27	54
12	INLET	33	34	39	41	42	42	43	26	49
	OUTLET	33	36	42	44	46	43	43	27	51

Sound power level spectrums in dB(A)

Working point		63	125	250	500	1000	2000	4000	8000	LwA
1	INLET	42	53	62	71	70	64	72	55	76
	OUTLET	45	57	65	73	77	66	72	55	80
2	INLET	44	53	62	70	66	64	67	53	74
	OUTLET	46	56	63	71	72	65	67	54	76
3	INLET	44	51	59	62	62	65	64	53	70
	OUTLET	47	54	60	66	65	66	64	53	72
4	INLET	38	49	58	67	66	60	68	51	72
	OUTLET	41	53	61	69	73	62	68	51	76
5	INLET	40	49	58	66	62	60	63	49	70
	OUTLET	42	52	59	67	68	61	63	50	72
6	INLET	41	48	56	59	59	62	61	50	67
	OUTLET	44	51	57	63	62	63	61	50	68
7	INLET	35	46	55	64	63	57	65	48	70
	OUTLET	38	50	58	66	70	59	65	48	73
8	INLET	38	47	56	64	60	58	61	47	67
	OUTLET	40	50	57	65	66	59	61	48	70
9	INLET	38	45	53	56	56	59	58	47	64
	OUTLET	41	48	54	60	59	60	58	47	66
10	INLET	28	39	48	57	56	50	58	41	63
	OUTLET	31	43	51	59	63	52	58	41	66
11	INLET	31	40	49	57	53	51	54	40	60
	OUTLET	33	43	50	58	59	52	54	41	63
12	INLET	31	38	46	49	49	52	51	40	57
	OUTLET	34	41	47	53	52	53	51	40	59

PERFORMANCE CURVES

- q_v : Airflow in m^3/h .
- p_{sf} : Static pressure in Pa.
- P: Input power in W.
- SFP: Specific Fan Power in $W/m^3/s$ (blue curves).
- Dry air at 20°C and 760 mmHg.
- Performance data in accordance with ISO 5801 and AMCA 210-99 Standards.

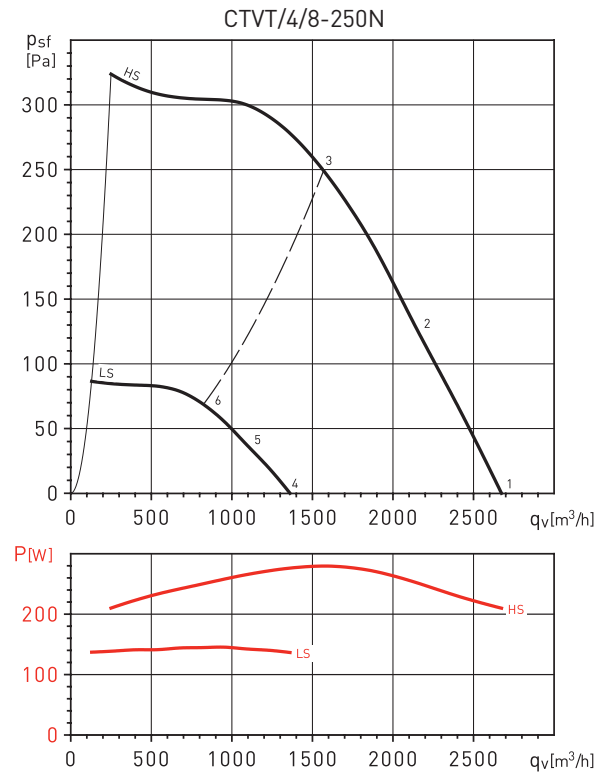
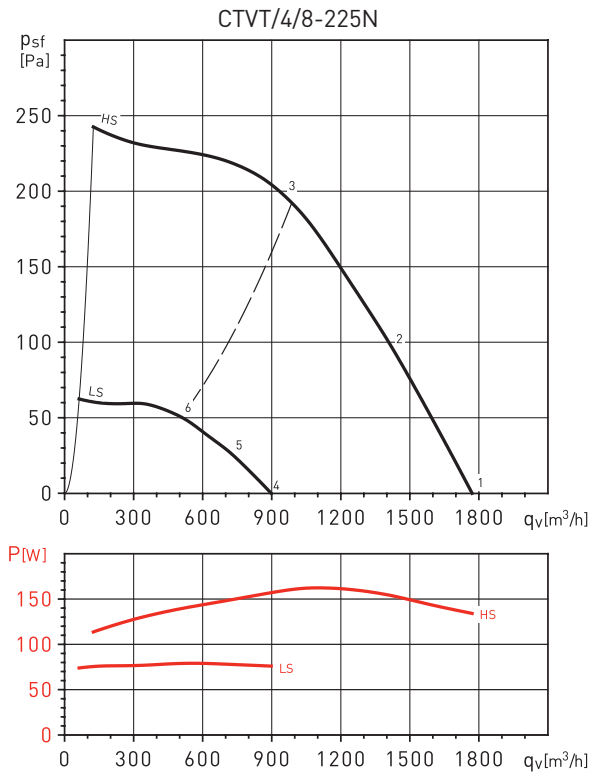

Sound power level spectrums in dB(A)

Working point		63	125	250	500	1000	2000	4000	8000	LwA
1	INLET	42	59	65	68	62	61	64	50	72
	OUTLET	46	61	64	71	69	66	64	52	75
2	INLET	42	56	63	67	60	58	57	45	70
	OUTLET	42	58	62	70	68	64	58	48	74
3	INLET	41	57	62	65	58	57	53	46	68
	OUTLET	42	58	61	68	65	62	55	48	71
4	INLET	28	45	51	54	48	47	50	36	58
	OUTLET	32	47	50	57	55	52	50	38	61
5	INLET	28	42	49	53	46	44	43	31	56
	OUTLET	28	44	48	56	54	50	44	34	59
6	INLET	26	42	47	50	43	42	38	31	53
	OUTLET	27	43	46	53	50	47	40	33	56

Sound power level spectrums in dB(A)

Working point		63	125	250	500	1000	2000	4000	8000	LwA
1	INLET	46	62	67	69	63	66	66	59	74
	OUTLET	47	65	70	70	70	70	67	58	77
2	INLET	44	59	65	67	62	66	58	54	72
	OUTLET	45	62	67	68	69	69	59	54	75
3	INLET	43	57	63	66	63	62	56	52	70
	OUTLET	45	61	66	67	69	66	60	53	74
4	INLET	32	48	53	55	49	52	52	45	60
	OUTLET	33	51	56	56	56	56	53	44	63
5	INLET	30	45	51	53	48	52	44	40	58
	OUTLET	31	48	53	54	55	55	45	40	61
6	INLET	29	43	49	52	49	48	42	38	57
	OUTLET	31	47	52	53	55	52	46	39	60

PERFORMANCE CURVES

- q_v : Airflow in m^3/h .
- p_{sf} : Static pressure in Pa.
- P: Input power in W.
- SFP: Specific Fan Power in $W/m^3/s$ (blue curves).
- Dry air at 20°C and 760 mmHg.
- Performance data in accordance with ISO 5801 and AMCA 210-99 Standards.

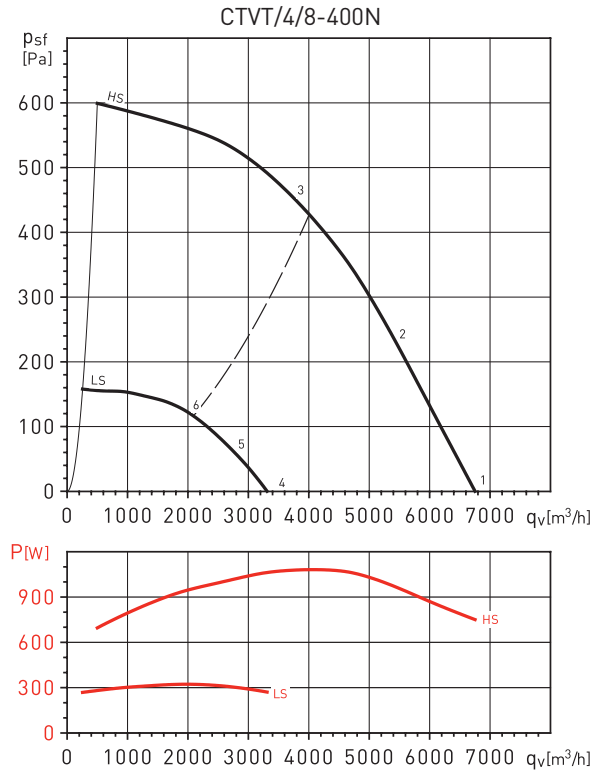
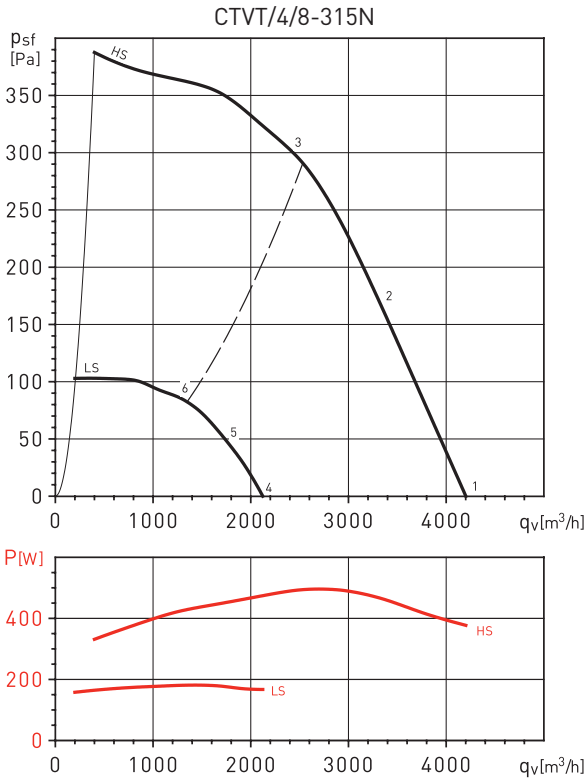

Sound power level spectrums in dB(A)

Working point		63	125	250	500	1000	2000	4000	8000	LwA
1	INLET	50	66	72	72	69	69	68	71	78
	OUTLET	51	69	75	75	75	72	68	70	81
2	INLET	48	63	69	69	67	66	62	63	75
	OUTLET	49	65	72	73	73	69	63	63	79
3	INLET	45	60	65	64	65	64	61	60	72
	OUTLET	45	62	67	68	70	67	62	60	75
4	INLET	36	51	58	58	55	55	54	57	64
	OUTLET	37	55	61	61	61	58	54	56	67
5	INLET	34	49	56	56	54	52	48	50	61
	OUTLET	35	52	59	59	60	56	49	50	65
6	INLET	32	46	51	51	52	51	48	46	58
	OUTLET	32	49	54	55	56	54	49	46	61

Sound power level spectrums in dB(A)

Working point		63	125	250	500	1000	2000	4000	8000	LwA
1	INLET	43	62	71	71	84	75	70	75	86
	OUTLET	58	71	74	76	87	81	74	75	89
2	INLET	42	60	72	70	79	70	66	67	81
	OUTLET	50	70	72	75	84	73	69	67	86
3	INLET	43	61	70	67	68	69	67	63	76
	OUTLET	47	67	70	72	73	71	69	64	79
4	INLET	29	48	57	57	70	61	56	61	71
	OUTLET	44	57	60	62	73	67	60	61	75
5	INLET	28	46	58	56	65	56	52	53	67
	OUTLET	36	56	58	61	70	59	55	53	71
6	INLET	29	47	56	53	54	55	53	49	62
	OUTLET	33	53	56	58	59	57	55	50	65

MOUNTING ACCESSORIES

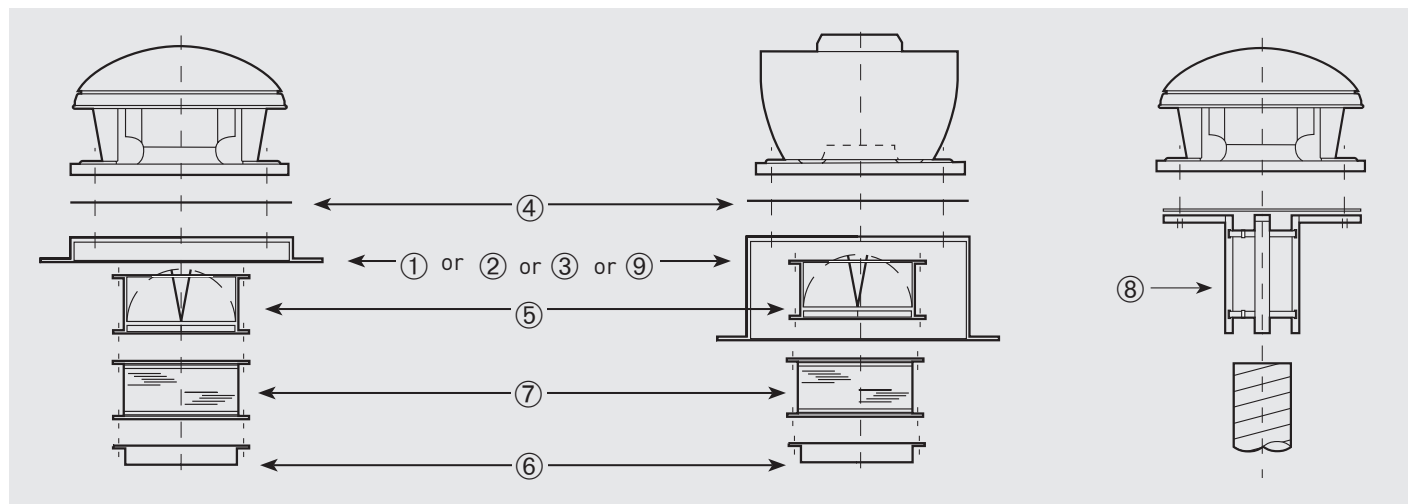

Fan model	① Sealing frame	② Flat roof insulated up stand	③ Acoustic up stand	④ Accessory adapter plate	⑤ Back draft shutter	⑥ Flange with spigot	⑦ Flexible coupling	⑧ Circular adapter	⑨ Support base for inclined curb mounted installations
180N	JMS-300	JBS-300	JAA-300	JPA-300	JCA-300	JBR-300 N	JAЕ-300 N	JCC-300	BI-3
200N 225N	JMS-435	JBS-435	JAA-435	JPA-435	JCA-435	JBR-435 N	JAЕ-435 N	JCC-435	BI-4
250N 315N	JMS-560	JBS-560	JAA-560	JPA-560	JCA-560-N	JBR-560 N	JAЕ-560 N	JCC-560	BI-5
400N	JMS-630	JBS-630	JAA-630	JPA-630	JCA-630-N	JBR-630 N	JAЕ-630 N	JCC-630	BI-6

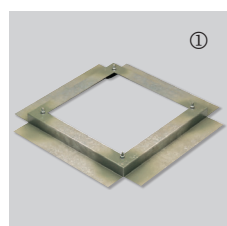

JMS Sealing frame
 - For mounting a roof fan on an up stand or base.
 - Supplied with screws and gasket for a complete weatherproof seal.

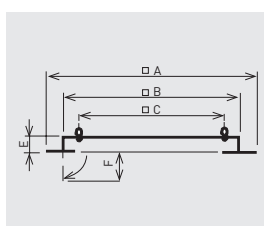

Model	□A	□B	□C	E	F
JMS-300	470	290	245	50	70
JMS-435	600	420	330	50	70
JMS-560	725	545	450	50	70
JMS-630	795	615	535	50	70



JBS Flat roof up stand
 For mounting a fan on a flat roof without up stands.
 - For use on horizontal roofs.
 - Internal insulation to prevent condensation.
 - Supplied with screws and gasket for a complete weather seal.

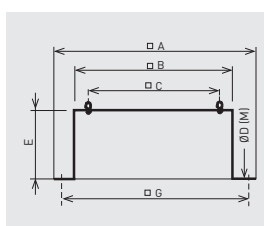

Model	□A	□B	□C	Ø D (M)	E	□G
JBS-300	470	289	245	10,5 (M8)	300	380
JBS-435	600	419	330	11 (M10)	300	510
JBS-560	725	544	450	11 (M10)	300	635
JBS-630	795	614	535	11 (M10)	300	705



JPA Accessory adapter plate
 - Used when mounting the accessories (JCA, JBR, JAE).
 - Allows the fan to be disconnected from the upstand without having to remove the duct.

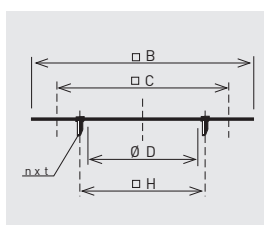

Model	□B	□C	Ø D	next	Ø H
JPA-300	289	245	182	4xM6	205
JPA-435	419	330	252	4xM8	280
JPA-560	544	450	358	8xM8	395
JPA-630	614	535	403	8xM10	450



JCA / JCA N Backdraft shutter
 - Prevents backdraft when the fan is not operating.
 - To be mounted at the fan inlet with the JPA plate.

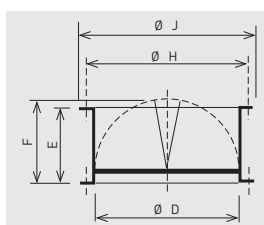

Model	Ø D	E	F	Ø H	Ø J
JCA-300	182	100	124	205	219
JCA-435	252	145	174	280	300
JCA-560-N	358	210	227	395	415
JCA-630-N	403	240	250	450	474

MOUNTING ACCESSORIES



JBR N Flange
 - For use when circular connection is required directly to the fan.
 - To be mounted at the fan inlet with the JPA plate or fixed directly to the fan base (rivets or screws not supplied).

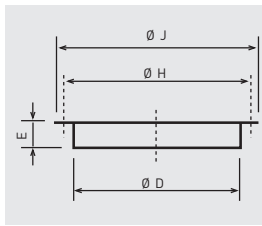

Model	Ø D	E	Ø H	Ø J
JBR-300 N	182	55	205	219
JBR-435 N	252	55	280	300
JBR-560 N	358	55	395	415
JBR-630 N	403	63	450	474

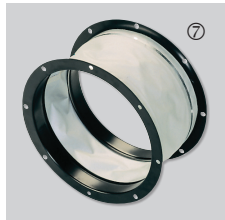

JAE N Flexible coupling
 - Reduces the transmission of vibrations when the duct is connected directly to the fan.
 - To be mounted at the fan inlet with JPA plate.

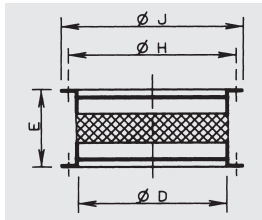

Model	Ø D	E	Ø H	Ø J
JAE-300 N	182	55	205	219
JAE-435 N	252	55	280	300
JAE-560 N	358	55	395	415
JAE-630 N	403	55	450	474



JCC Adapter for circular duct
 - For use when fitting the models up to 400, directly to a spirally wound circular duct.

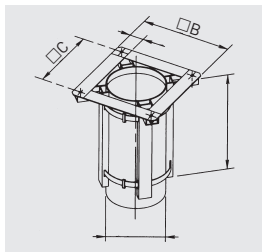

Model	Ø B	Ø C	Ø D	E	L
JCC-300	290	245	180	45	350
JCC-435	390	330	250	60	350
JCC-560	520	450	355	70	350
JCC-630	605	535	400	70	350



BI Support base for inclined curb mounted installations
 - To ensure a proper installation of the MAXTEMP roof fan it is essential to specify the roof pitch angle and the distance between the roof beam profiles.

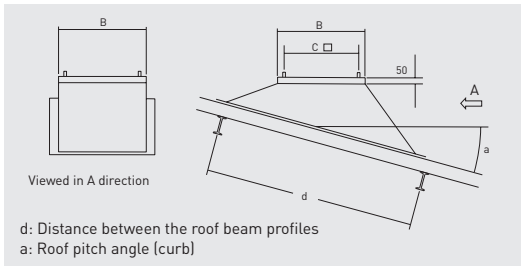

Model	B	C
BI-3	289	245
BI-4	419	330
BI-5	544	450
BI-6	614	535



JAA Acoustic up stand
 - Reduces in duct and radiated noise.
 - For use when mounting a fan on a flat roof without up stands.
 - Supplied with screws and gasket for a complete weather seal.

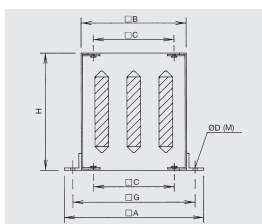

Model	Ø A	Ø B	Ø C	Ø D (M)	H	Ø G
JAA-300	470	290	245	13 (M10)	750	380
JAA-435	600	419	330	15 (M12)	750	510
JAA-560	725	545	450	15 (M12)	750	635
JAA-630	795	615	535	15 (M12)	750	705

Acoustic attenuation in dB(A) at the corresponding frequency band in Hz.

Model	125	250	500	1000	2000	4000	8000
JAA-300	1	5	13	22	23	16	12
JAA-435	1	7	16	23	25	18	13
JAA-560	2	8	16	29	32	26	17
JAA-630	2	8	14	24	27	19	13

JAA Attenuator pressure drops.

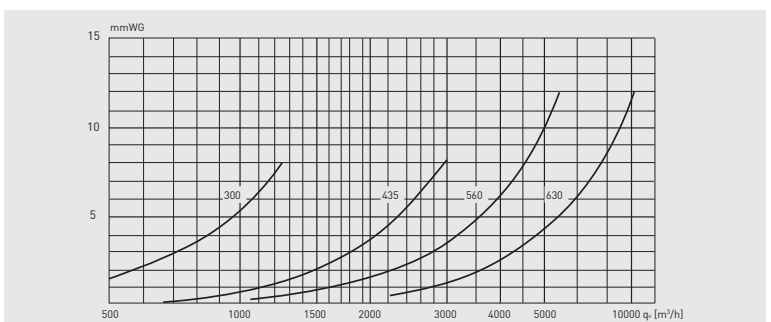

MOUNTING ACCESSORIES

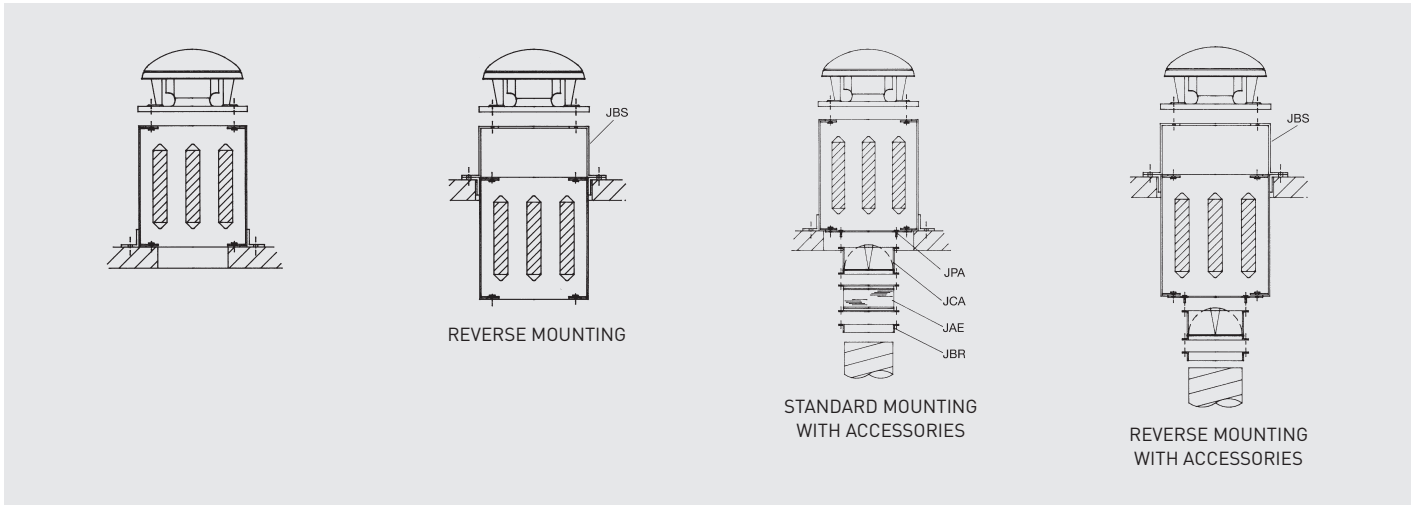

ELECTRICAL ACCESSORIES

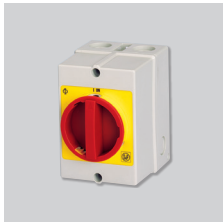

On/ Off Electrical isolation switch
 - Switch On/ Off 5P (1 speed motor)
 - Switch On/ Off 8P (2 speed motor).



REB-1N / REB-2,5N
 Single phase electronic speed controllers.
 - For use with the single phase roof fans.



REB-5 / REB-10
 Single phase electronic speed controllers.
 - For use with the single phase roof fans.



RMB/RMT
 Auto transformer speed controllers.
 - For single phase and three phase roof fans models.



VAPZ
 Electronic single phase regulator that controls the fan speed with a simple contact (presence detector) or an analogical input 0-10 V or 4-20 mA (from CO2 probe or relative humidity sensor).



VRPU
 Electronic control with display for single phase 230V-50/60Hz fans. Analogical input 0-10V or 4-20mA: Operating regulation, either with setting value or external signal (current or voltage).



VFTM IP21
 Adjustable frequency drives for three phase motors from 0,37 to 15 kW. DIN rail mounting



VFTM IP54
 Adjustable frequency drives for three phase motors from 0,37 to 15 kW.



VFKB IP65
 Adjustable frequency drive for three phase motors from 0,37 to 4 kW.



DEMZ DA
 Switch for 2-speed motors with Dahlander.