

# Technical Data Sheet

Compressor model **HLY90AAa**  
 Voltage **220-240V 50Hz ~1**  
 Refrigerant **R600a**

## APPLICATION

Application Low Back Pressure  
 Refrigerant R600a  
 Evaporating Temp. -35,0 °C to -10,0 °C  
 Expansion Capillar  
 Comp. Cooling Static  
 Max. ambient temp. 43,0 °C

## COMPRESSOR

Displacement 9,09 cm<sup>3</sup>  
 Diameter 24,29 mm  
 Stroke 19,62 mm  
 Net Weight 9,85 Kg  
 Oil type ISO VG 10 MINER  
 Oil charge 345 cm<sup>3</sup>

## MOTOR

Nominal Power 1/6 hp  
 Voltage/Frequency 220-240V 50Hz  
 Voltage range 187-264 V  
 Type RSIR  
 Phase number 1 PH  
 Locked Rotor Amps (LRA) 9,30 A  
 Max. Cont. Current (MCC) 1,10 A  
 Main W. resist. at 25°C 17,64 Ω  
 Start W. resist. at 25°C 21,62 Ω

## NOMINAL PERFORMANCE

	ASHRAE	CECOMAF
Cooling Capacity	125 kCal/h	109 W
COP	1,41 W/W	1,11 W/W
EER	1,21 kCal/Wh	0,96 kCal/Wh
Input Power	103 W	98 W
Current	0,71 A	0,69 A

## APPROVALS



## TEST CYCLE CONDITIONS

	ASHRAE LBP (B)	CECOMAF LBP (A)
Evaporating temp. (T <sub>e</sub> )	-23,3 °C	-25,0 °C
Condensing temp. (T <sub>c</sub> )	55,0 °C	55,0 °C
Liquid temp. (T <sub>liq.</sub> )	32,0 °C	55,0 °C
Ambient temp. (T <sub>amb.</sub> )	32,0 °C	32,0 °C
Suction temp. (T <sub>suction</sub> )	32,0 °C	32,0 °C
Voltage/Frequency	220 V 50 Hz	220 V 50 Hz

## ELECTRICAL COMPONENTS

Relay	Option 1			
Reference	PTC K100			
Voltage	200-240 V			
Resistance	14.00 Ω			
Protector	Option 1	Option 2	Option 3	Option 4
Reference	MSP331LZ	4TM222NFBYY	T0366	AE37FJ
Current	6,20 A	7,00 A	6,80 A	5,90 A
Time check	7,5-14 seg	5-15 seg	7,5-14 seg	7,5-14 seg
Disc temp. (Open/Close)	120,00 / 61,00 °C	120,00 / 61,00 °C	120,00 / 62,00 °C	115,00 / 62,00 °C

This product is approved for R290 and R600a regarding explosion safety according to standard EN 60335-1 and EN 60335-2-34

## ASHRAE

Tc °C	Te °C	Cooling Capacity kCal/h	Consumption W	Current A	COP W/W	EER kCal/Wh
40	-35	83	82	0,64	1,18	1,01
40	-30	103	89	0,66	1,33	1,15
40	-25	130	99	0,69	1,53	1,32
40	-23,3	141	102	0,71	1,60	1,38
40	-20	166	110	0,74	1,75	1,50
40	-15	209	124	0,79	1,97	1,69
40	-10	261	139	0,86	2,18	1,88

45	-35	79	80	0,63	1,14	0,98
45	-30	98	88	0,66	1,29	1,11
45	-25	125	99	0,69	1,47	1,26
45	-23,3	136	103	0,71	1,54	1,32
45	-20	160	111	0,74	1,68	1,44
45	-15	203	125	0,80	1,88	1,62
45	-10	254	142	0,87	2,09	1,80

50	-35	74	78	0,63	1,11	0,95
50	-30	93	87	0,66	1,24	1,06
50	-25	120	99	0,69	1,41	1,21
50	-23,3	130	103	0,71	1,48	1,27
50	-20	154	112	0,74	1,60	1,38
50	-15	197	127	0,81	1,80	1,55
50	-10	248	144	0,89	2,00	1,72

55	-35	70	76	0,62	1,07	0,92
55	-30	88	86	0,65	1,19	1,02
55	-25	114	98	0,69	1,35	1,16
55	-23,3	125	103	0,71	1,41	1,21
55	-20	148	113	0,75	1,53	1,32
55	-15	191	129	0,81	1,72	1,48
55	-10	241	147	0,90	1,91	1,64

60	-35	66	74	0,61	1,03	0,89
60	-30	83	85	0,65	1,14	0,98
60	-25	109	98	0,69	1,29	1,11
60	-23,3	120	103	0,71	1,35	1,16
60	-20	143	113	0,75	1,46	1,26
60	-15	185	131	0,82	1,64	1,41
60	-10	234	150	0,91	1,82	1,57

## CECOMAF

Tc °C	Te °C	Cooling Capacity W	Consumption W	Current A	COP W/W	EER kCal/Wh
40	-35	91	82	0,64	1,11	0,96
40	-30	114	89	0,66	1,28	1,10
40	-25	146	99	0,69	1,47	1,27
40	-23,3	158	102	0,71	1,54	1,33
40	-20	184	110	0,74	1,67	1,45
40	-15	231	124	0,79	1,87	1,61
40	-10	285	139	0,86	2,05	1,77

45	-35	83	80	0,63	1,04	0,90
45	-30	104	88	0,66	1,18	1,02
45	-25	134	99	0,69	1,35	1,17
45	-23,3	145	103	0,71	1,41	1,22
45	-20	170	111	0,74	1,53	1,33
45	-15	215	125	0,80	1,71	1,48
45	-10	267	142	0,87	1,89	1,63

50	-35	75	78	0,63	0,96	0,83
50	-30	94	87	0,66	1,08	0,93
50	-25	122	99	0,69	1,23	1,07
50	-23,3	132	103	0,71	1,29	1,11
50	-20	156	112	0,74	1,40	1,21
50	-15	199	127	0,81	1,56	1,35
50	-10	249	144	0,89	1,72	1,49

55	-35	67	76	0,62	0,88	0,76
55	-30	84	86	0,65	0,98	0,85
55	-25	109	98	0,69	1,11	0,96
55	-23,3	120	103	0,71	1,16	1,00
55	-20	142	113	0,75	1,26	1,09
55	-15	183	129	0,81	1,42	1,22
55	-10	231	147	0,90	1,57	1,36

60	-35	59	74	0,61	0,80	0,69
60	-30	75	85	0,65	0,88	0,76
60	-25	97	98	0,69	0,99	0,86
60	-23,3	107	103	0,71	1,04	0,90
60	-20	128	113	0,75	1,13	0,98
60	-15	166	131	0,82	1,28	1,10
60	-10	212	150	0,91	1,42	1,23

## EN12900

X	Cooling Capacity (W)	Consumption (W)	Current (A)	Mass Flow (kg/h)
1	589,0153655660	142,8150511052	0,8959571519	5,9122801259898
2	17,6982302799	2,6618525031	0,0154293840	0,20037272090477
3	-4,5548902139	0,9268321694	0,0042506326	-0,019983253320047
4	0,1487490151	0,0411578517	0,0002761064	0,0021460198133777
5	-0,0849738040	0,0381507246	0,0001574865	-0,00024937309519459

Equation	$x_1 + x_2Te + x_3Tc + x_4Te^2 + x_5TeTc$
----------	---

## COMPRESSOR DIMENSIONS

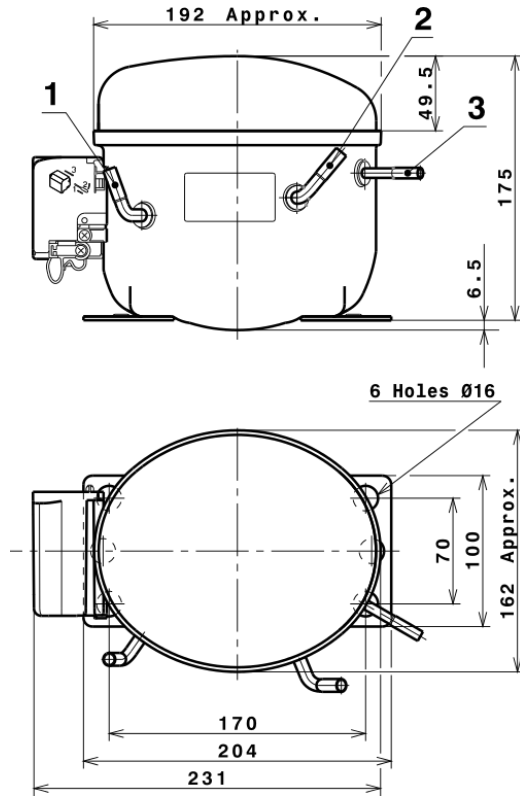

## DESIGNATION INTERNAL DIAM.

DESIGNATION	INTERNAL DIAM.
1 Suction	6,5 mm
2 Service	6,5 mm
3 Discharge	4,9 mm

## WIRING DIAGRAMS AND ELECTRICAL ASSEMBLY

### RSIR CONNECTION (PTC) (L, P ranges)



## FIXINGS

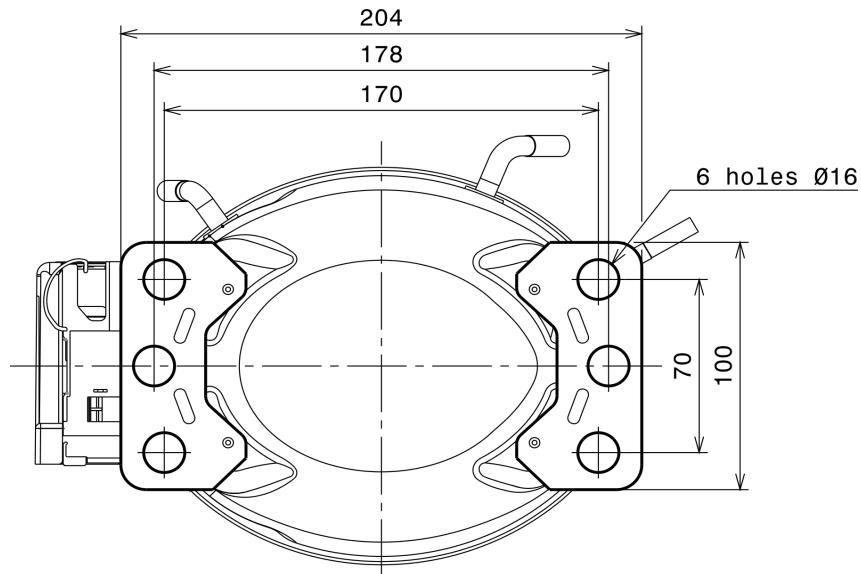

## SILENT BLOCKS (MOUNTING ACCESSORIES)

### STANDARD

Ø16 holes (170x70 net)

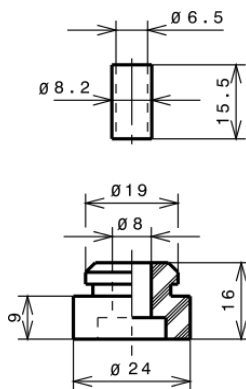

### SNAP-ON

Ø16 holes (170x70 net)

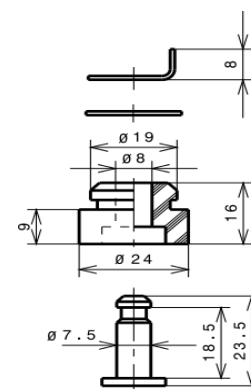

## SOA

SOA R600a LBP

