

Condensing Unit Technical Data Sheet

Model CMPT18LA_N
Voltage 220-240V 50Hz ~1
Refrigerant R404A

APPLICATION

Application	Low Back Pressure
Refrigerant	R404A
Evaporating Temp.	-40,0 °C to -10,0 °C
Expansion	Capillar/Valve
Comp. Cooling	Fan cooled
Max. ambient temp.	43,0 °C

COMPRESSOR

Displacement	18,00 cm ³
Diameter	32,60 mm
Stroke	21,11 mm
Oil type	ISO VG 32 ESTER
Oil charge	400 cm ³

MOTOR

Nominal Power	1/2 hp
Voltage/Frequency	220-240V 50Hz
Voltage range	187-255 V
Type	CSR
Phase number	1 PH
Locked Rotor Amps (LRA)	26,00 A
Max. Cont. Current (MCC)	5,90 A
Main W. resist. at 25°C	3,24 Ω
Start W. resist. at 25°C	9,48 Ω

NOMINAL PERFORMANCE

Cooling Capacity	920 W
COP	1,37 W/W
EER	1,18 kCal/Wh
Input Power	672 W
Current	2,30 A

ASHRAE

TEST CYCLE CONDITIONS

	LBP
Evaporating temp. (T _e)	-23,3 °C
Condensing temp. (T _c)	55,0 °C
Liquid temp. (T _{liq.})	32,0 °C
Ambient temp. (T _{amb.})	32,0 °C
Suction temp. (T _{suction})	32,0 °C
Voltage/Frequency	220 V 50 Hz

CONDENSER AND FAN DATA

Condenser type	CU-AL
Condenser model	10T 4R
Fan blade (Ø mm / °)	230 / 28
Fan motor	10W 230V 50/60Hz

WIRING DIAGRAM

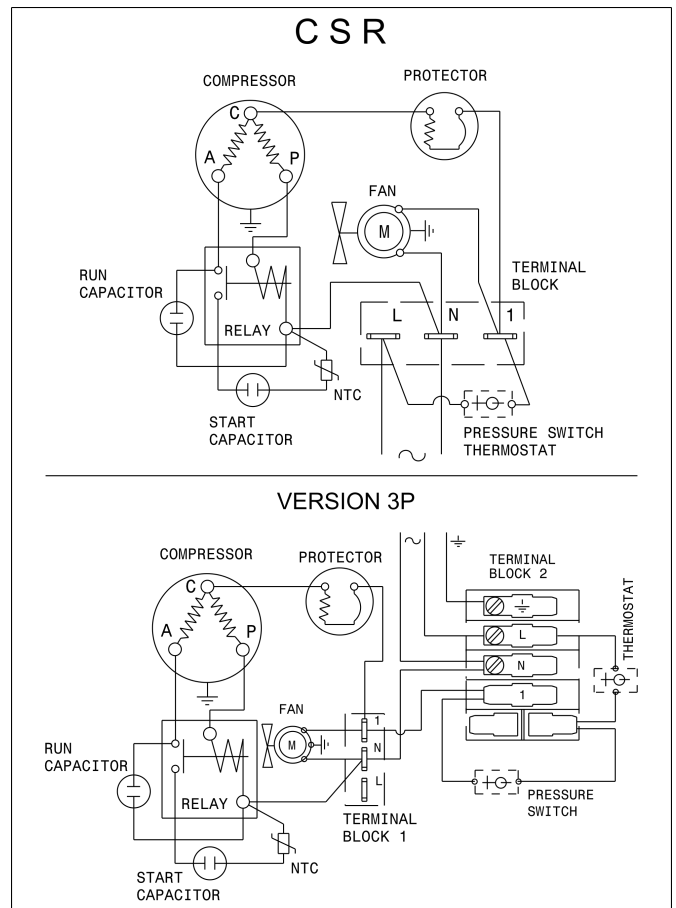

REFRIGERATION CAPACITY (W)

Evaporating Temperature (°C)

Model	Motor	-40	-35	-30	-25	-23.3			-10
						W	Winp	A	
CMPT18LA_N	CSR	470	620	726	909	920	672	2.3	1350

ASHRAE LBP: Condensing temperature: 55°C, Liquid temperature: 32°C, Suction temperature: 32°C, Ambient temperature: 32°C

Condensing Unit Technical Data Sheet

VERSIONS

VERSION 1	VERSION 2	VERSION 3	VERSION 3P	VERSION 4
Tube	Service valve	Service valve and receiver	Service valve, receiver, pressure switch	Schrader valve on the service port
Suction tube internal diam.: 8,1 mm Discharge tube internal diam.: 6,5 mm Net Weight: 28,5 Kg	Suction valve: 3/8" Discharge valve: 3/8" Net Weight: 29,0 Kg	Receiver vol.: 1,1 l Suction valve: 3/8" Discharge valve: 3/8" Net Weight: 29,8 Kg	Receiver vol.: 1,1 l Suction valve: 3/8" Discharge valve: 3/8" Net Weight: 30,9 Kg	Suction tube internal diam.: 8,1 mm Discharge tube internal diam.: 6,5 mm Net Weight: 28,5 Kg

DIMENSIONS (Version 3 drawing)

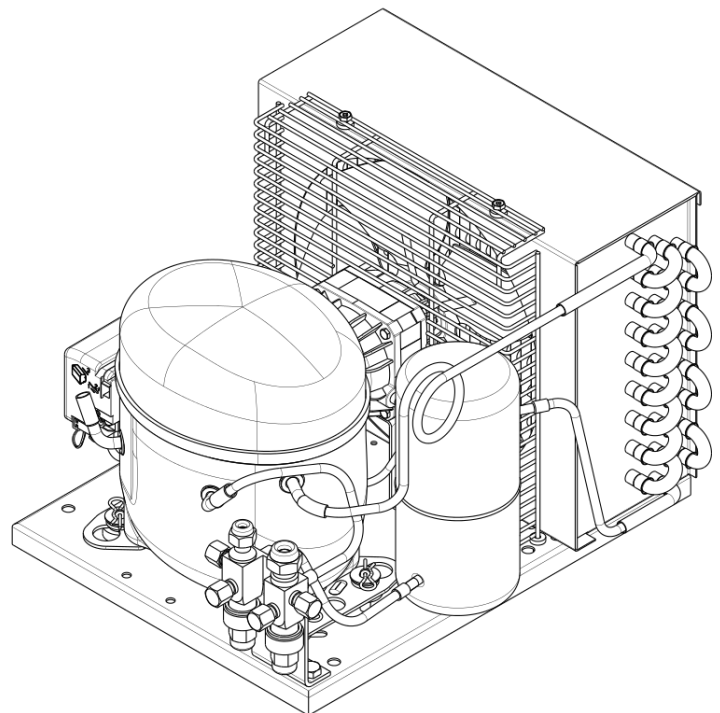
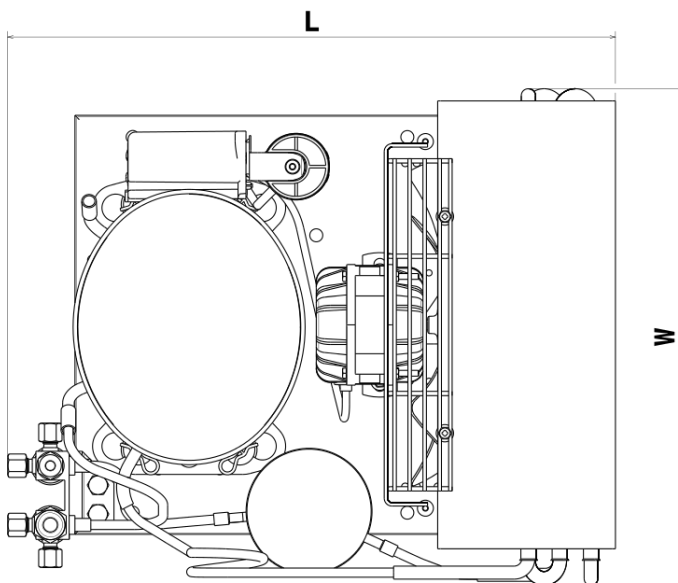
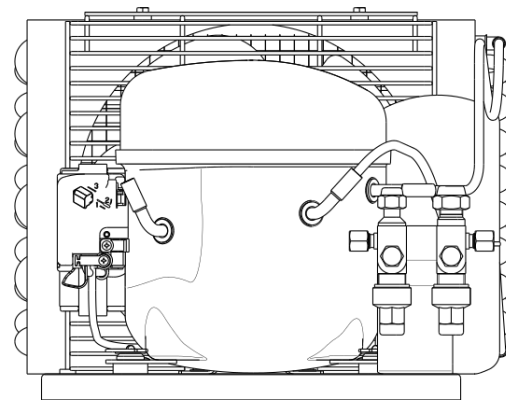
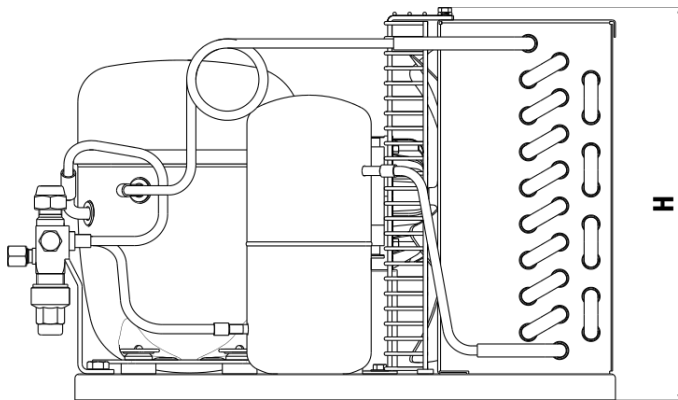

VERSION 1-4 (WxLxH) (mm)	VERSION 2 (WxLxH) (mm)	VERSION 3 (WxLxH) (mm)	VERSION 3P (WxLxH) (mm)
350x490x300	350x510x300	350x510x300	350x545x300