

# Condensing Unit Technical Data Sheet

**Model** CML45TB\_N  
**Voltage** 220-240V 50Hz ~1  
**Refrigerant** R404A

## APPLICATION

Application High-Medium Back Pressure  
 Refrigerant R404A  
 Evaporating Temp. -25,0 °C to 10,0 °C  
 Expansion Capillar/Valve  
 Comp. Cooling Fan cooled  
 Max. ambient temp. 43,0 °C

## COMPRESSOR

Displacement 4,56 cm<sup>3</sup>  
 Diameter 19,09 mm  
 Stroke 15,93 mm  
 Oil type ISO VG 32 ESTER  
 Oil charge 300 cm<sup>3</sup>

## MOTOR

Nominal Power 1/5 hp  
 Voltage/Frequency 220-240V 50Hz  
 Voltage range 187-264 V  
 Type CSIR  
 Phase number 1 PH  
 Locked Rotor Amps (LRA) 9,70 A  
 Max. Cont. Current (MCC) 3,20 A  
 Main W. resist. at 25°C 12,00 Ω  
 Start W. resist. at 25°C 30,00 Ω

## NOMINAL PERFORMANCE

Cooling Capacity	662 W
COP	1,72 W/W
EER	1,47 kCal/Wh
Input Power	386 W
Current	2,02 A

## ASHRAE

## TEST CYCLE CONDITIONS

	HMBP
Evaporating temp. (T <sub>e</sub> )	7,2 °C
Condensing temp. (T <sub>c</sub> )	55,0 °C
Liquid temp. (T <sub>liq.</sub> )	46,0 °C
Ambient temp. (T <sub>amb.</sub> )	35,0 °C
Suction temp. (T <sub>suction</sub> )	35,0 °C
Voltage/Frequency	220 V 50 Hz

## CONDENSER AND FAN DATA

Condenser type	CU-AL
Condenser model	8T 2R
Fan blade (Ø mm / °)	200 / 28
Fan motor	5W 230V 50/60Hz

## WIRING DIAGRAM

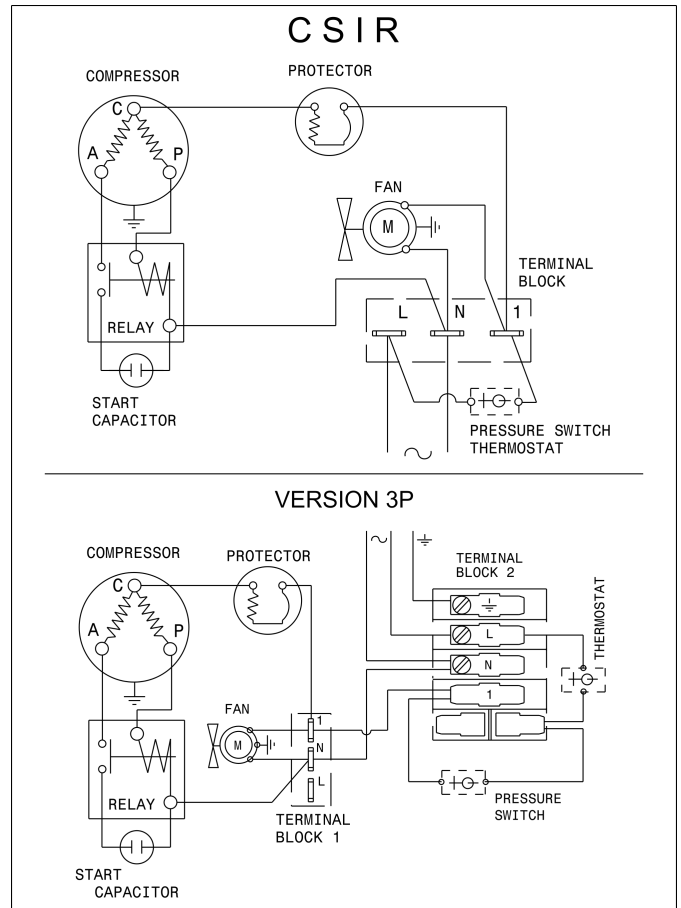

## REFRIGERATION CAPACITY (W) Evaporating Temperature (°C)

Model	Motor	-25	-15	-5	5	7.2			10
						W	Winp	A	
CML45TB_N	CSIR	215	328	464	623	662	386	2.02	712

ASHRAE HMBP: Condensing temperature: 55°C, Liquid temperature: 46°C, Suction temperature: 35°C, Ambient temperature: 35°C

# Condensing Unit Technical Data Sheet

## VERSIONS

VERSION 1	VERSION 2	VERSION 3	VERSION 3P	VERSION 4
<b>Tube</b>	<b>Service valve</b>	<b>Service valve and receiver</b>	<b>Service valve, receiver, pressure switch</b>	<b>Schrader valve on the service port</b>
Suction tube internal diam.: 6,5 mm Discharge tube internal diam.: 4,9 mm Net Weight: 13,9 Kg	Suction valve: 3/8" Discharge valve: 1/4" Net Weight: 14,4 Kg	Receiver vol.: 0,9 l Suction valve: 3/8" Discharge valve: 1/4" Net Weight: 14,7 Kg	Receiver vol.: 0,9 l Suction valve: 3/8" Discharge valve: 1/4" Net Weight: 15,8 Kg	Suction tube internal diam.: 6,5 mm Discharge tube internal diam.: 4,9 mm Net Weight: 13,9 Kg

## DIMENSIONS (Version 3 drawing)

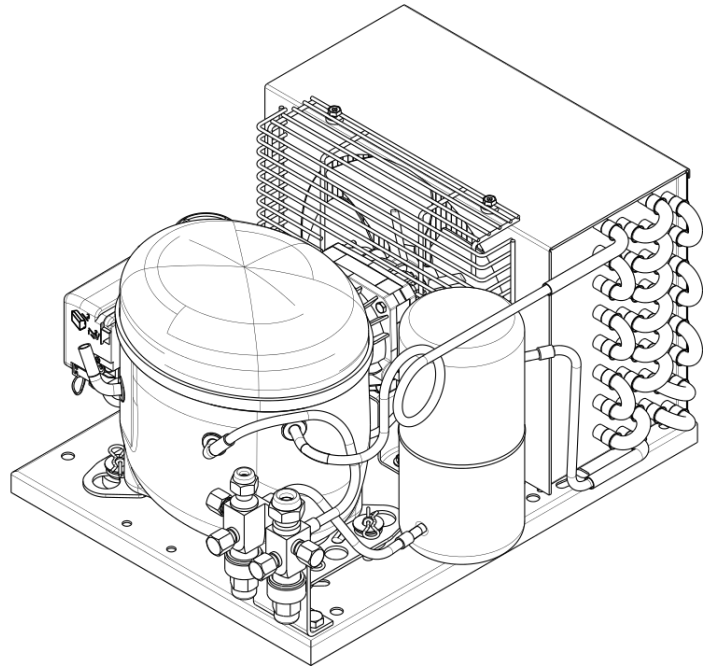
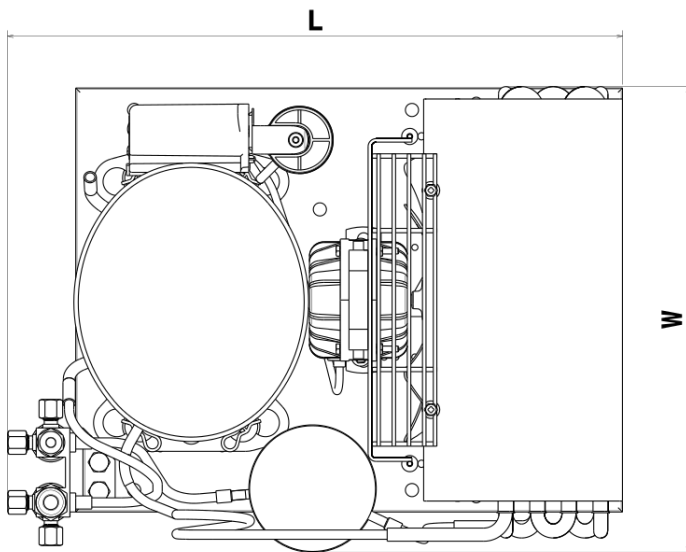
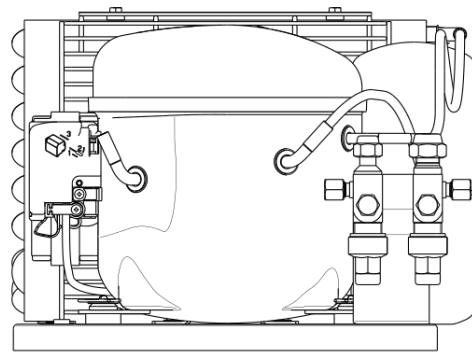
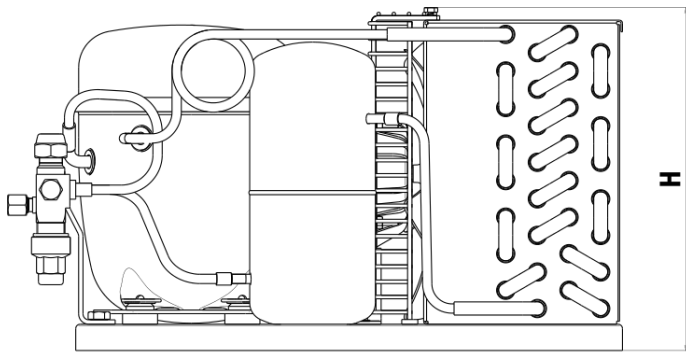

VERSION 1-4 (WxLxH) (mm)	VERSION 2 (WxLxH) (mm)	VERSION 3 (WxLxH) (mm)	VERSION 3P (WxLxH) (mm)
305x385x235	315x425x235	320x425x235	330x435x245