

Condensing Unit Technical Data Sheet

Model CGLY80RAa_N
Voltage 220-240V 50Hz ~1
Refrigerant R134a

APPLICATION

Application High-Medium Back Pressure
 Refrigerant R134a
 Evaporating Temp. -25,0 °C to 10,0 °C
 Expansion Capillar/Valve
 Comp. Cooling Fan cooled
 Max. ambient temp. 43,0 °C

COMPRESSOR

Displacement 8,10 cm³
 Diameter 24,29 mm
 Stroke 17,47 mm
 Oil type ISO VG 32 ESTER
 Oil charge 345 cm³

MOTOR

Nominal Power 1/5 hp
 Voltage/Frequency 220-240V 50Hz
 Voltage range 187-264 V
 Type CSIR
 Phase number 1 PH
 Locked Rotor Amps (LRA) 10,00 A
 Max. Cont. Current (MCC) 3,50 A
 Main W. resist. at 25°C 8,55 Ω
 Start W. resist. at 25°C 18,40 Ω

NOMINAL PERFORMANCE

Cooling Capacity	858 W
COP	2,46 W/W
EER	2,11 kCal/Wh
Input Power	349 W
Current	2,02 A

ASHRAE

TEST CYCLE CONDITIONS

	HMBP
Evaporating temp. (T _e)	7,2 °C
Condensing temp. (T _c)	55,0 °C
Liquid temp. (T _{liq.})	46,0 °C
Ambient temp. (T _{amb.})	35,0 °C
Suction temp. (T _{suction})	35,0 °C
Voltage/Frequency	220 V 50 Hz

CONDENSER AND FAN DATA

Condenser type	CU-AL
Condenser model	8T 4R
Fan blade (Ø mm / °)	200 / 28
Fan motor	5W 230V 50/60Hz

WIRING DIAGRAM

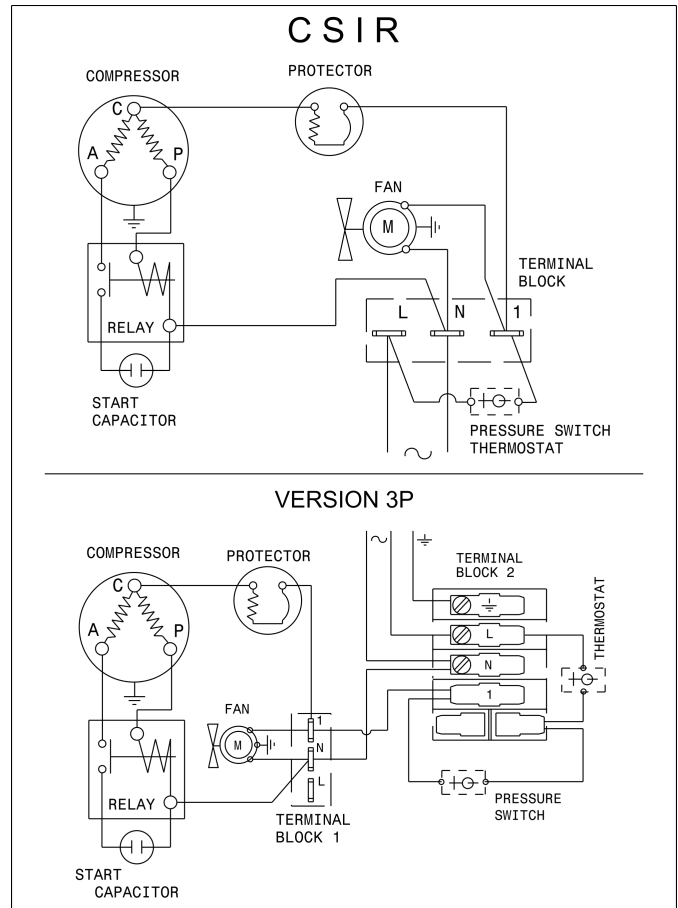

REFRIGERATION CAPACITY (W) Evaporating Temperature (°C)

Model	Motor	-25	-15	-5	5	7.2			10
						W	Winp	A	
CGLY80RAa_N	CSIR	219	351	543	795	858	349	2.02	943

ASHRAE HMBP: Condensing temperature: 55°C, Liquid temperature: 46°C, Suction temperature: 35°C, Ambient temperature: 35°C

Condensing Unit Technical Data Sheet

VERSIONS

VERSION 1	VERSION 2	VERSION 3	VERSION 3P	VERSION 4
Tube	Service valve	Service valve and receiver	Service valve, receiver, pressure switch	Schrader valve on the service port
Suction tube internal diam.: 6,5 mm Discharge tube internal diam.: 4,9 mm Net Weight: 17,7 Kg	Suction valve: 3/8" Discharge valve: 1/4" Net Weight: 18,2 Kg	Receiver vol.: 0,9 l Suction valve: 3/8" Discharge valve: 1/4" Net Weight: 18,5 Kg	Receiver vol.: 0,9 l Suction valve: 3/8" Discharge valve: 1/4" Net Weight: 19,6 Kg	Suction tube internal diam.: 6,5 mm Discharge tube internal diam.: 4,9 mm Net Weight: 17,7 Kg

DIMENSIONS (Version 3 drawing)

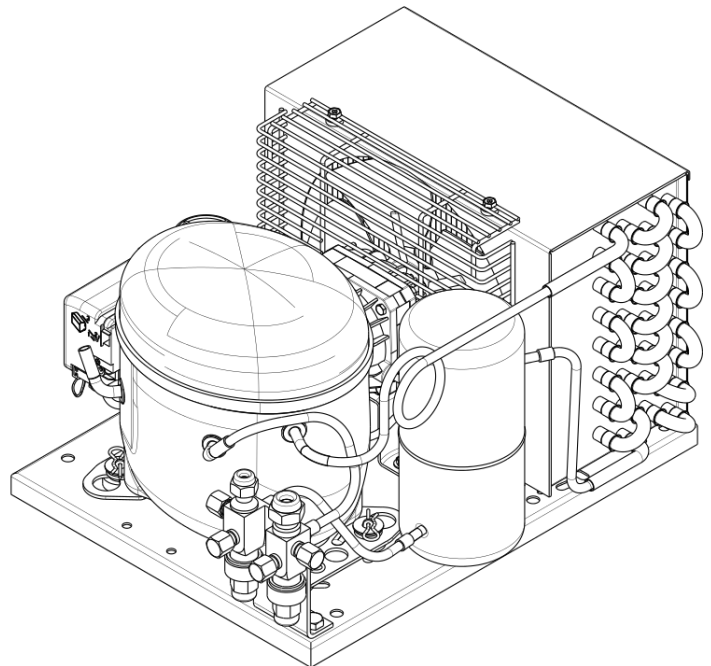
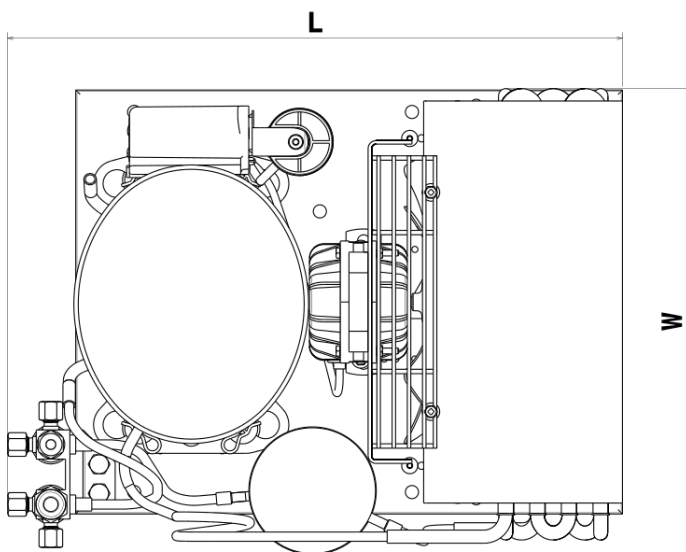
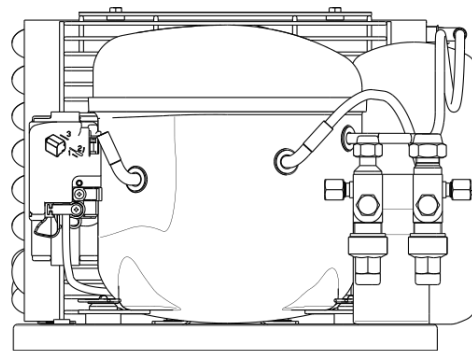
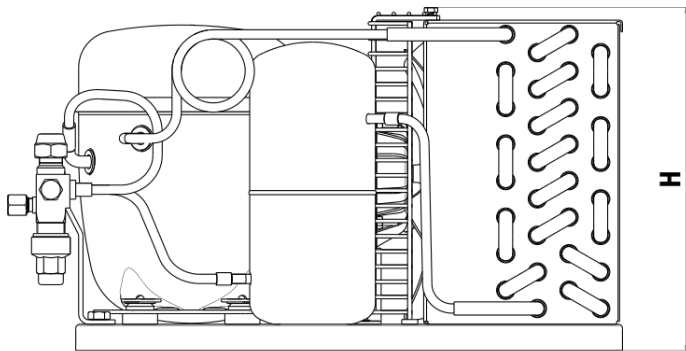

VERSION 1-4 (WxLxH) (mm)	VERSION 2 (WxLxH) (mm)	VERSION 3 (WxLxH) (mm)	VERSION 3P (WxLxH) (mm)
315x385x235	315x425x235	320x425x235	330x435x245